

ESL

*ILLUSTRATIONS
FOR SKILL BOOK 1
LAUBACH WAY
TO READING*

LAUBACH WAY TO
ENGLISH
Illustrations **1**

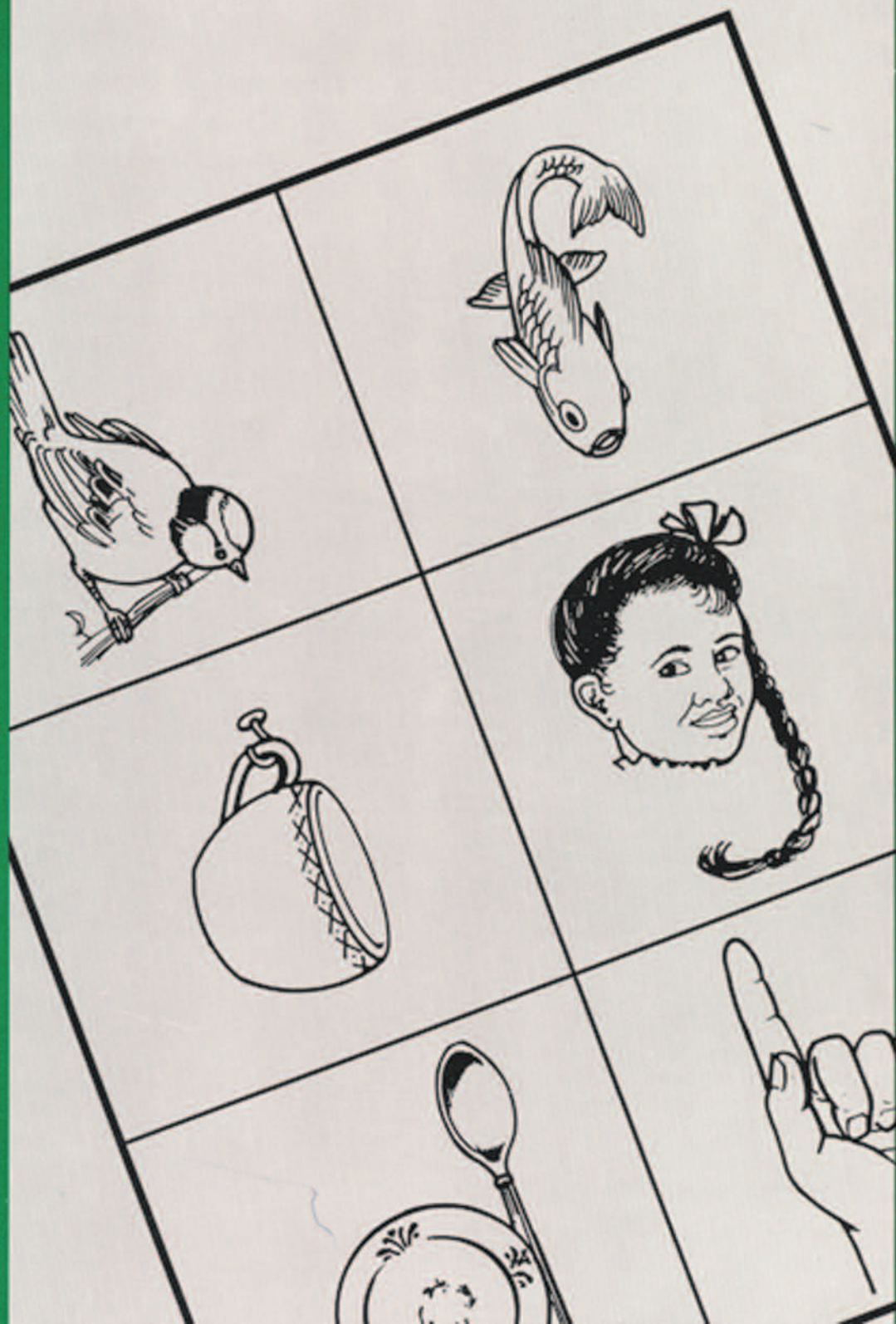

Jeanette D. Macero

LAUBACH WAY TO ENGLISH

ILLUSTRATIONS

FOR SKILL BOOK

1

LAUBACH WAY TO READING

Illustrations in this book are to be used by the teacher to show the student the meaning of vocabulary and structures introduced in conversations skills sections of the *ESL Teacher's Manual for Skill Book 1*.

For the teacher's convenience, words and sentences are given in small print to identify the pictures. These words and sentences can easily be covered if the teacher does not want the student to see them during conversation skills practice.

ISBN 0-88336-392-5

© 1976, revised 1980, 1991 New Readers Press
New Readers Press
Division of ProLiteracy Worldwide
1320 Jamesville Avenue,
Syracuse, New York 13210
www.newreaderspress.com

All rights reserved. No part of this book may be reproduced or transmitted in any form or by any means, electronic or mechanical, including photocopying, recording, or by any information storage and retrieval system, without permission in writing from the publisher.

Printed in the United States of America
20 19 18 17 16 15 14 13 12

All proceeds from the sale of New Readers Press materials support literacy programs in the United States and worldwide.

Illustrations: Kathy Pirk

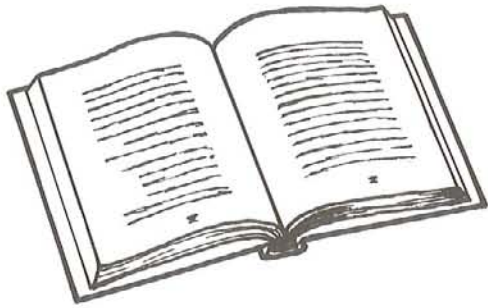

book

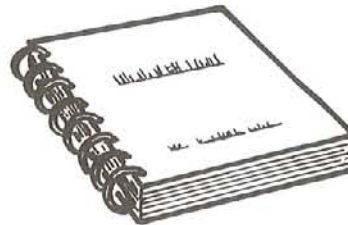

books



pen

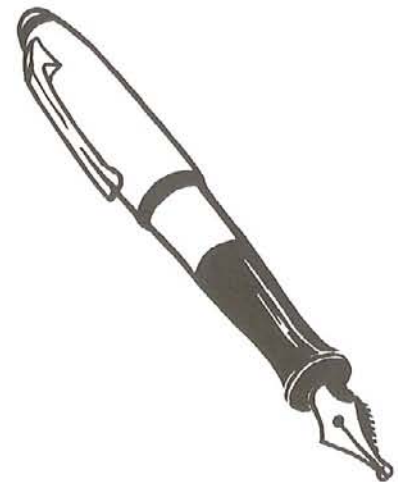

pens



pencil

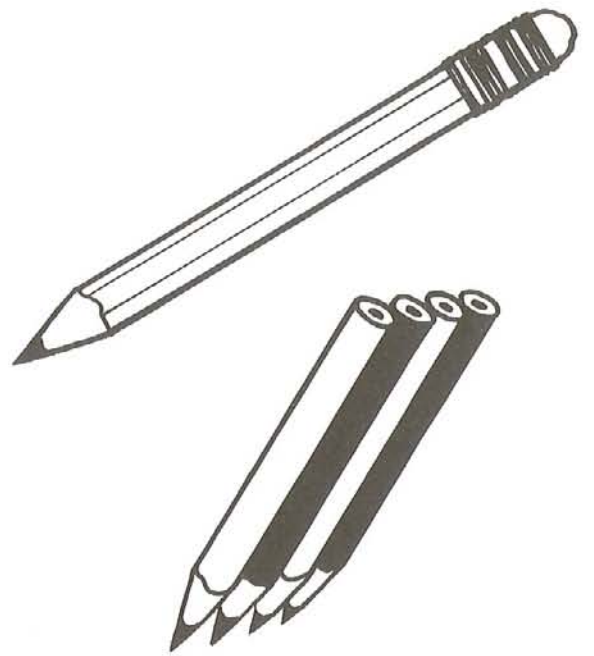

pencils

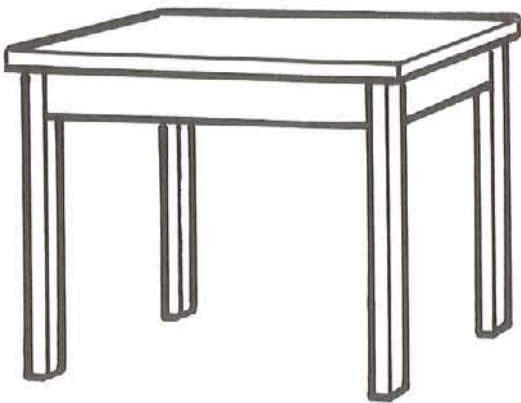

table

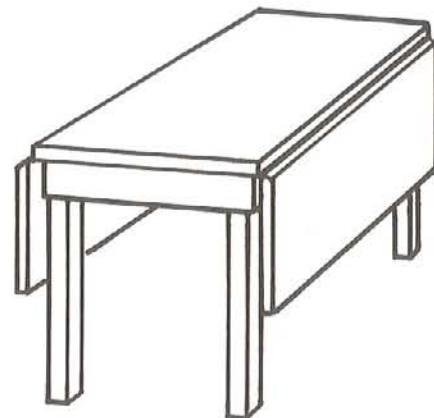

tables





desk



desks



chair

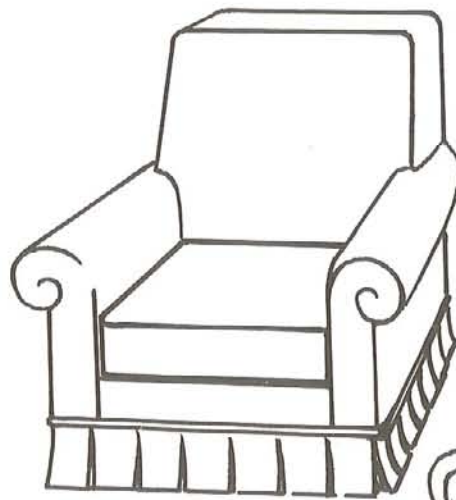

chairs

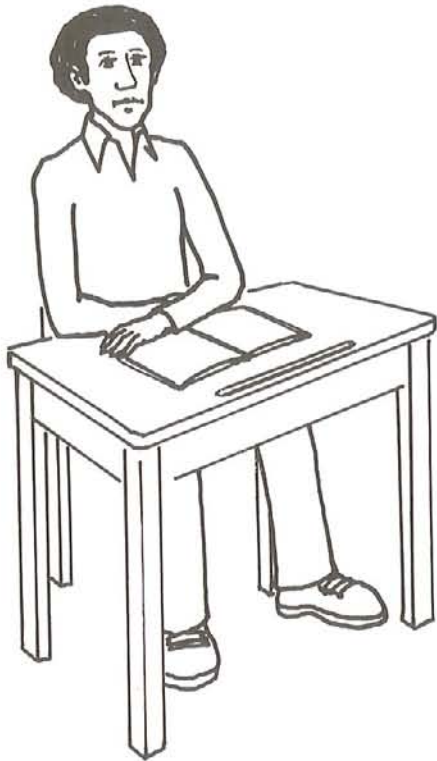

student



teacher

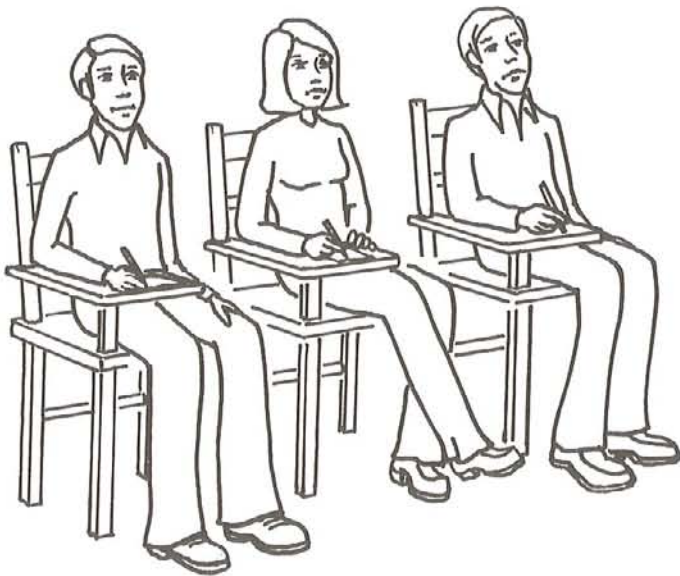

students



teachers

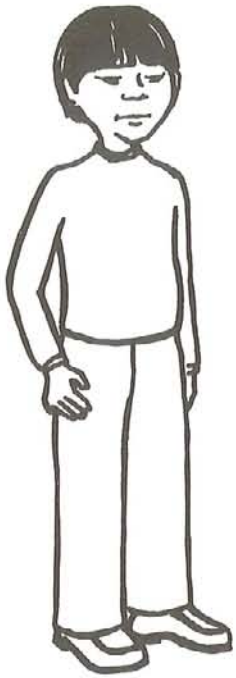

boy



boys

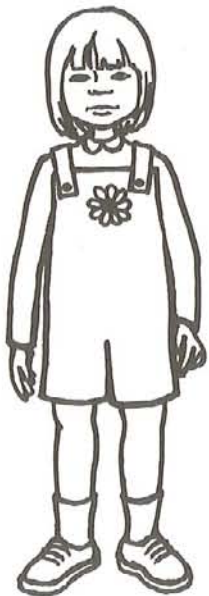

girl



girls

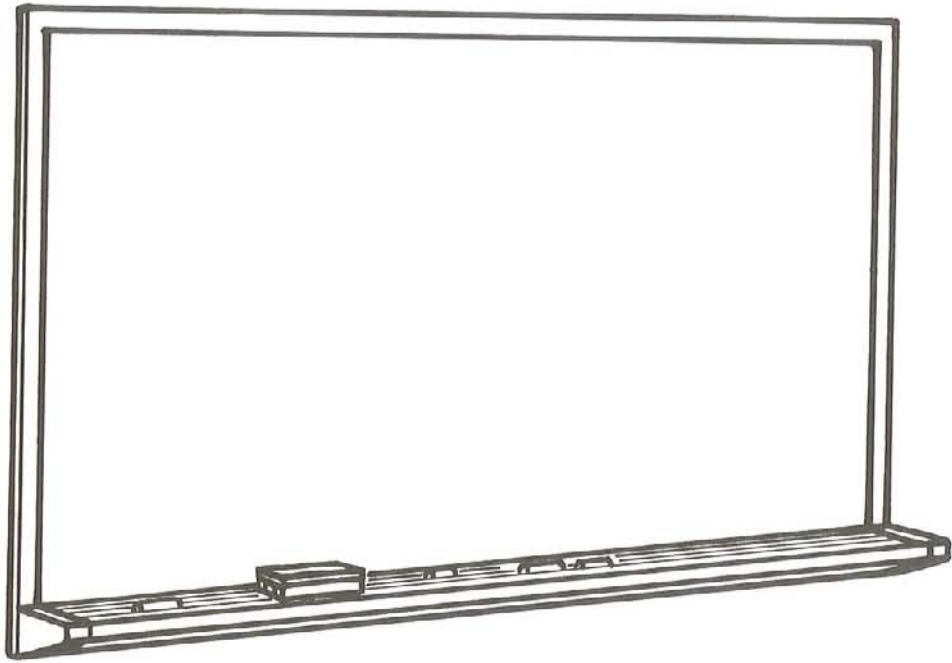

blackboard

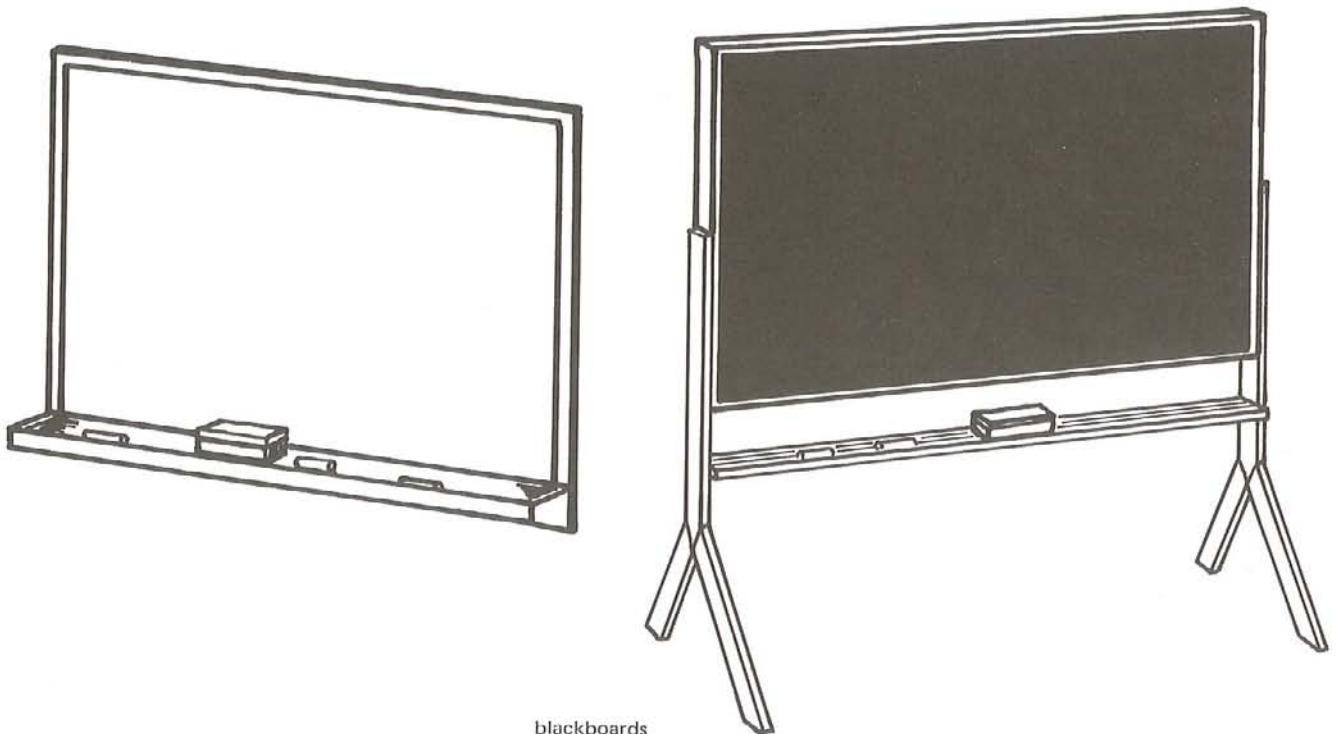

blackboards

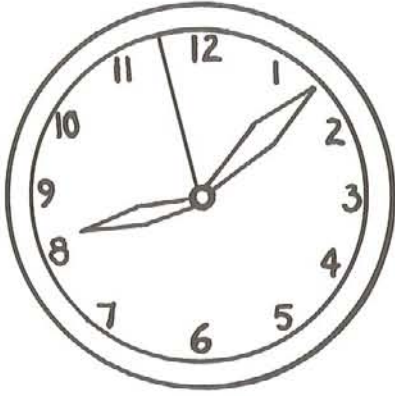

clock

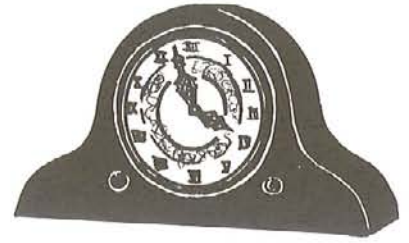
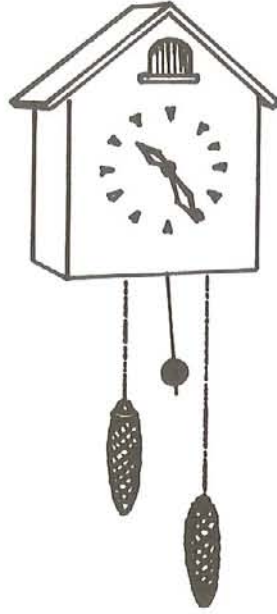

clocks

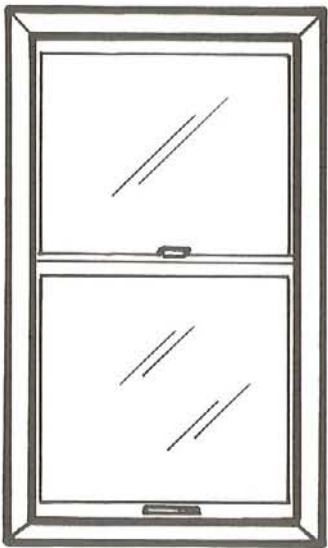

window

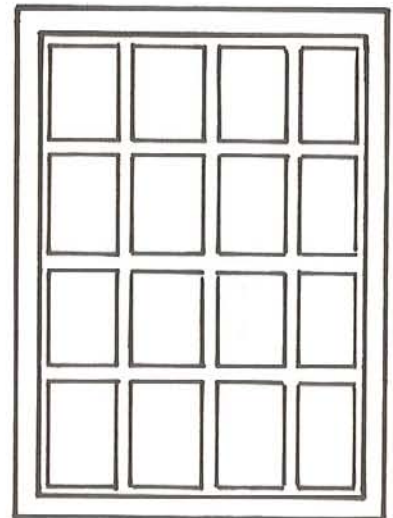
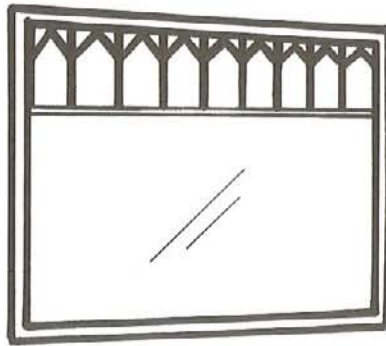

windows

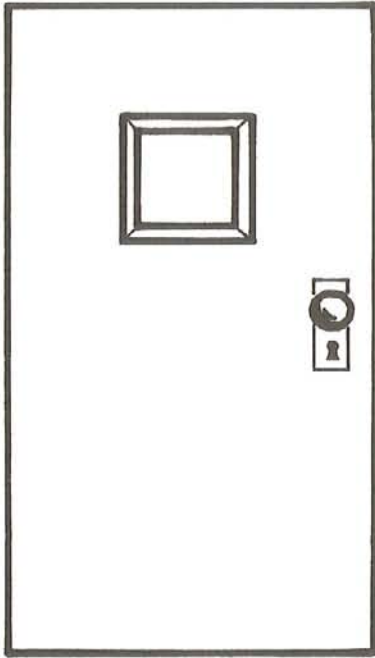

door

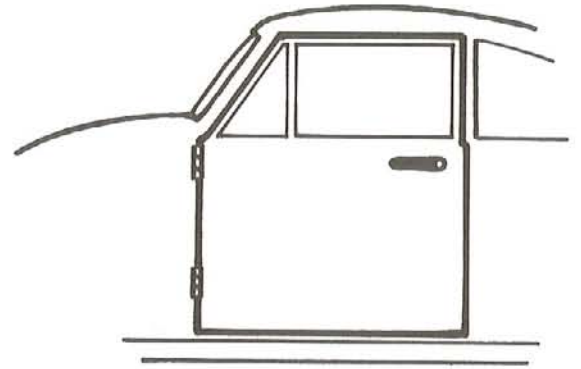
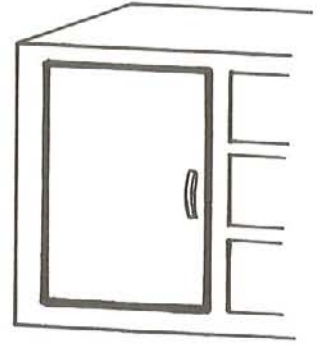
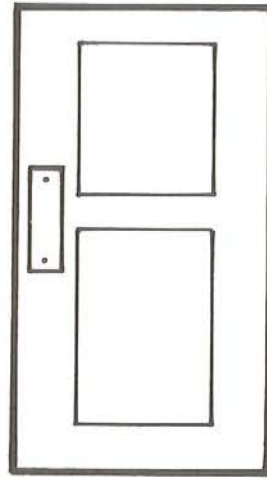

doors



eraser

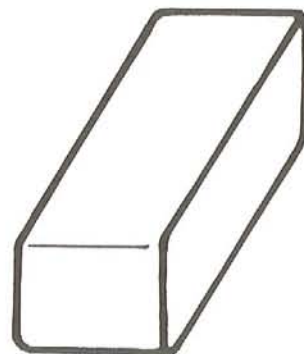
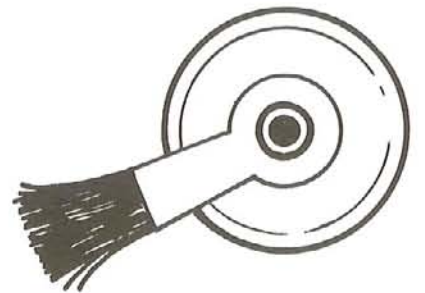

erasers

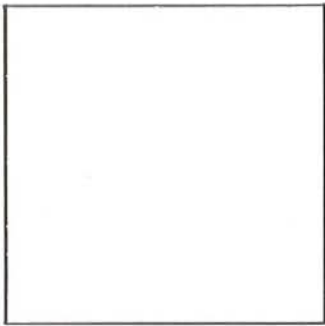
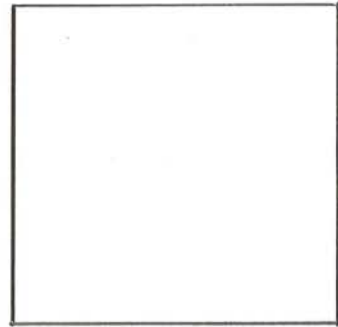
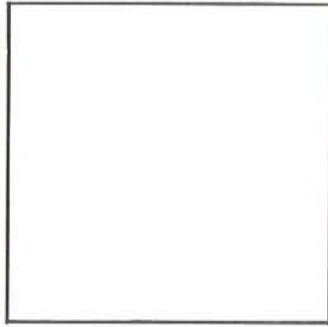
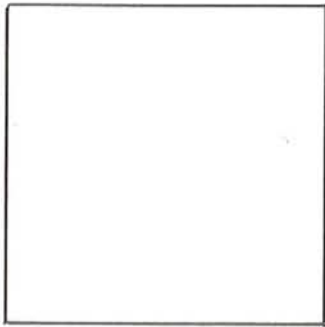
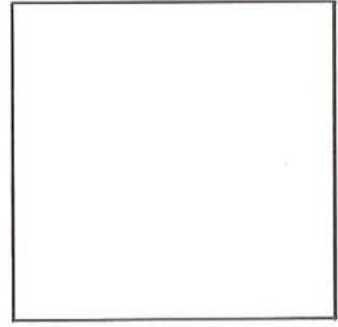
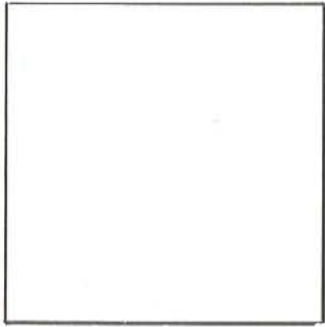



doctor



doctors

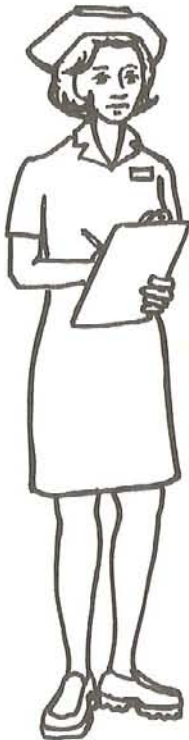

nurse



nurses



waiter



waitress

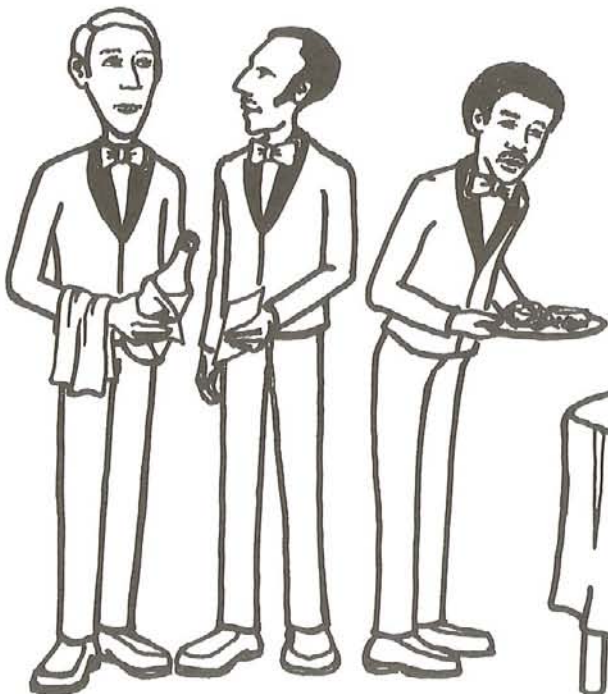

waiters

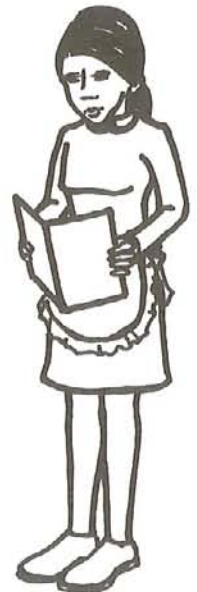

waitresses

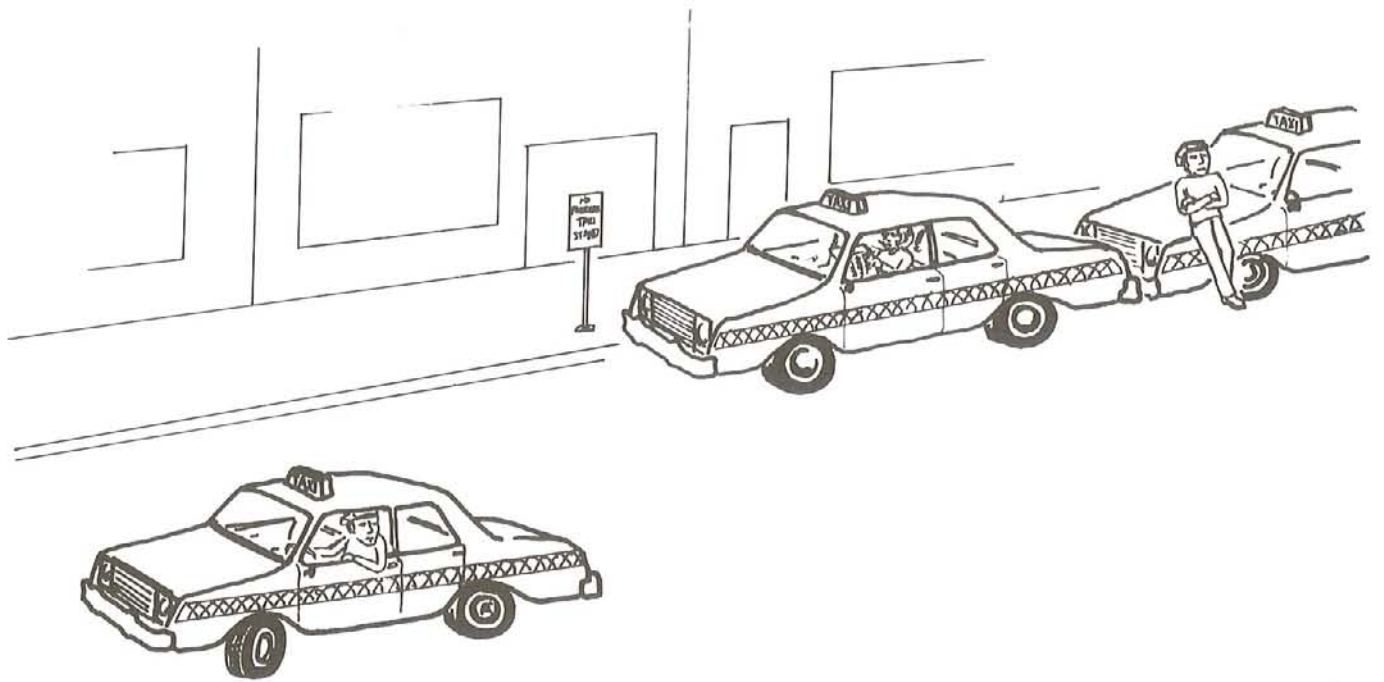

taxi driver

taxi drivers

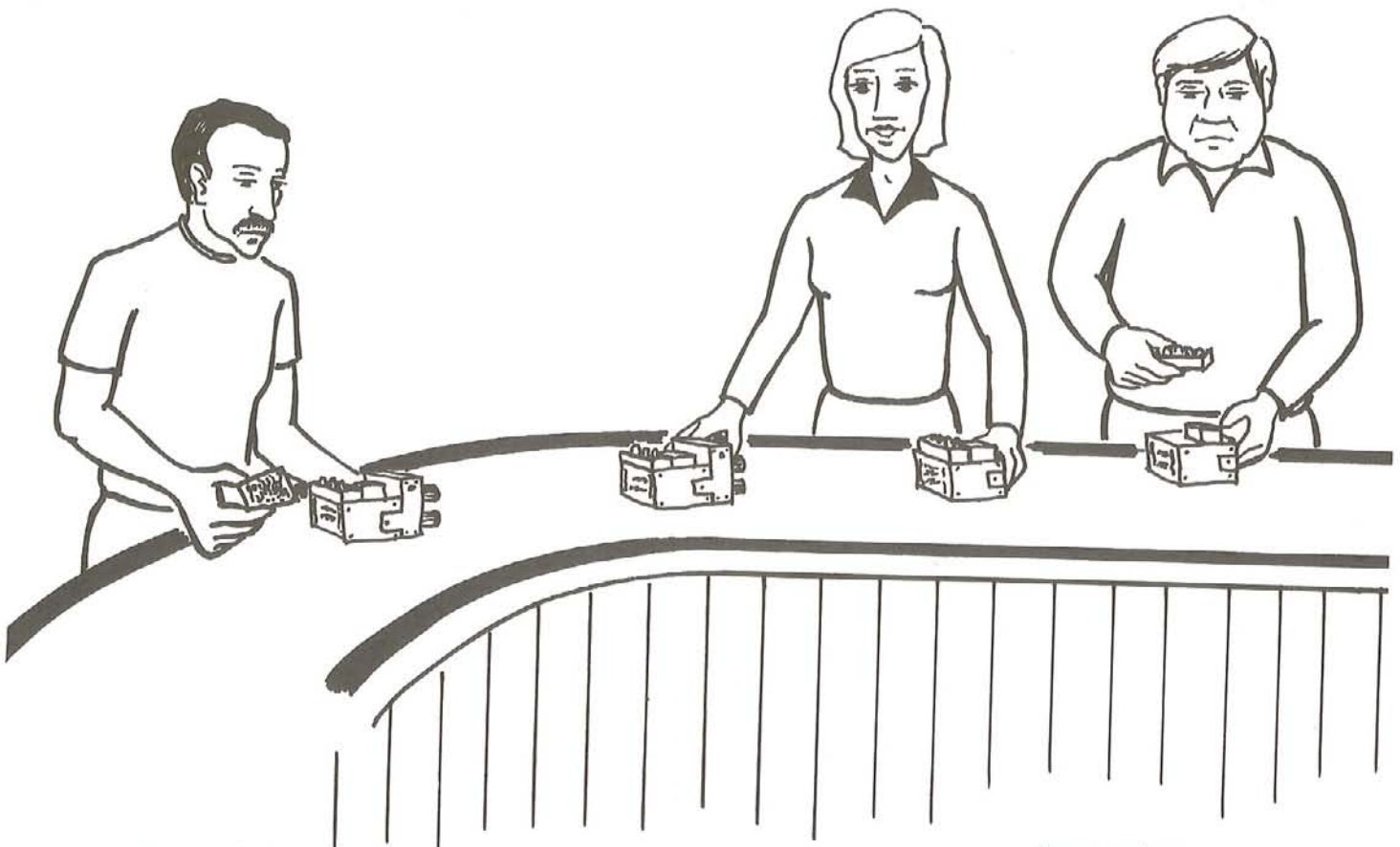

factory worker

factory workers

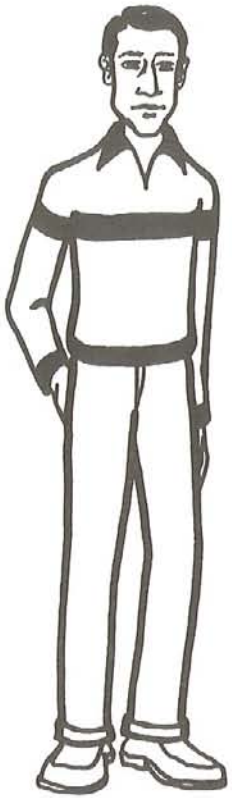

man

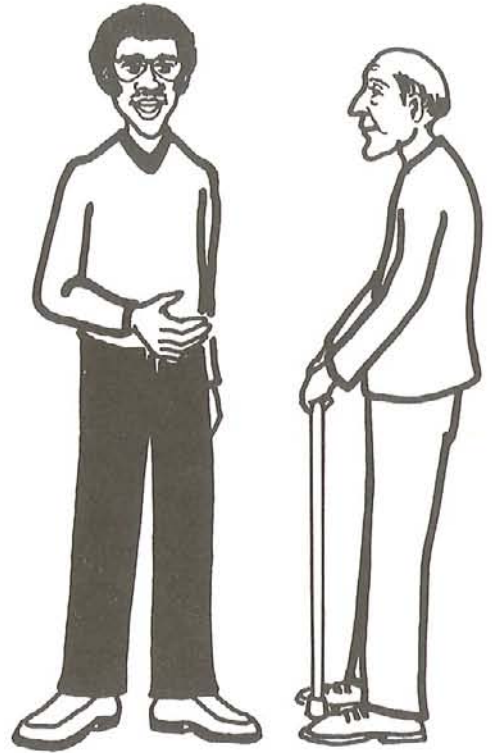

men

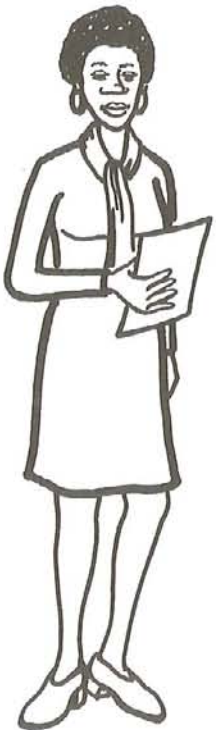

woman



women

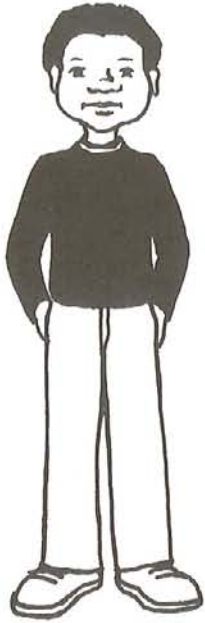

child

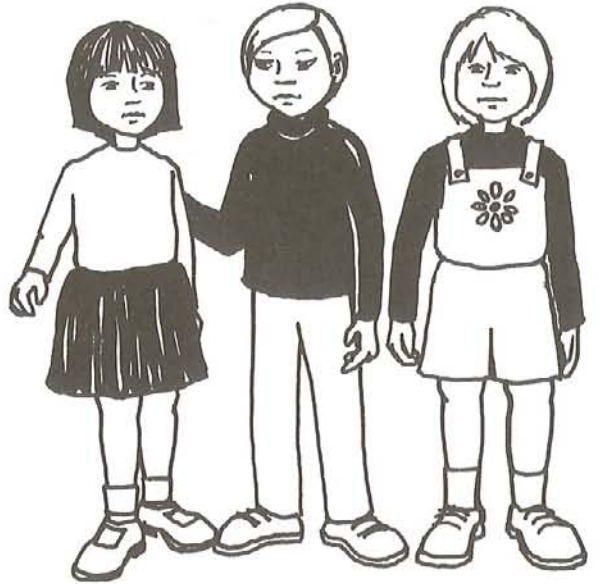

children



housewife



housewives





KEY

- | | | | | | |
|------------------|-------------------|---------------|---------------|----------------------|------------------------|
| 1 Honduras | 9 Luxembourg | 17 Bosnia | 25 Cyprus | 33 U.A.E. | 41 Sao Tome & Principe |
| 2 El Salvador | 10 Switzerland | 18 Montenegro | 26 Lebanon | 34 The Gambia | 42 Rwanda |
| 3 Jamaica | 11 Czech Republic | 19 Serbia | 27 Israel | 35 Guinea Bissau | 43 Burundi |
| 4 Haiti | 12 Slovakia | 20 Moldova | 28 Jordan | 36 Guinea | 44 Djibouti |
| 5 Lithuania | 13 Austria | 21 Bulgaria | 29 Georgia | 37 Ghana | 45 Kampuchea |
| 6 United Kingdom | 14 Hungary | 22 Albania | 30 Armenia | 38 Togo | 46 East Timor |
| 7 Netherlands | 15 Slovenia | 23 Macedonia | 31 Azerbaijan | 39 Benin | |
| 8 Belgium | 16 Croatia | 24 Greece | 32 Qatar | 40 Equatorial Guinea | |

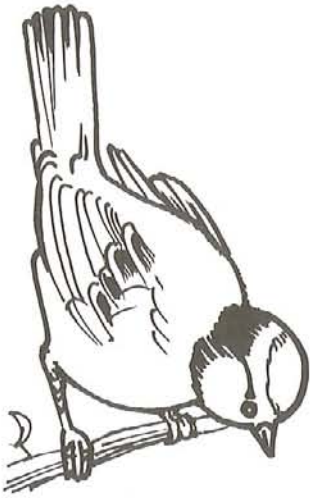

bird

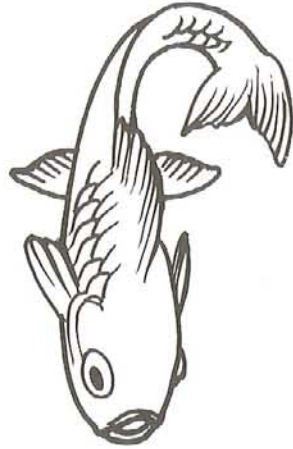

fish

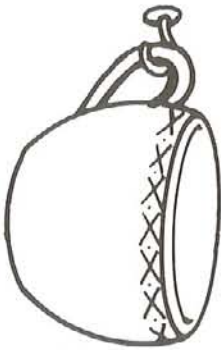

cup



girl



dish



hand

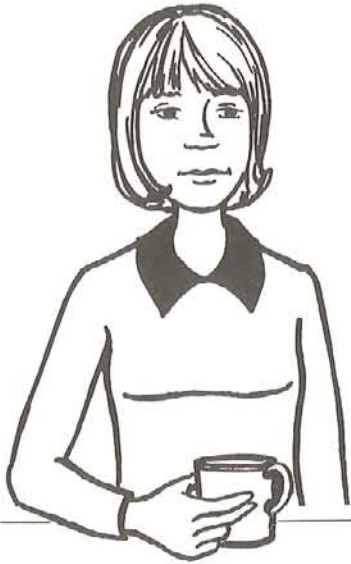

The girl has a cup.



The girls have cups.

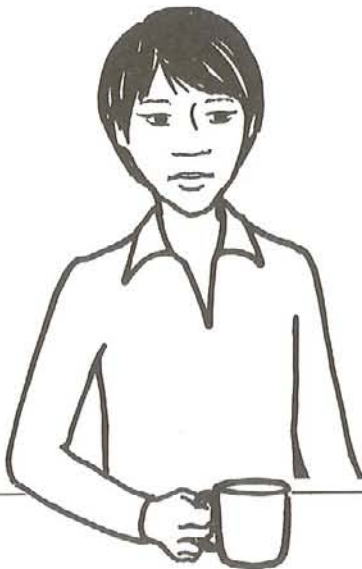

The boy has a cup.



The men have cups.



Ann has her book.
She has her cup.
She has her book.
The girl has a cup in her hand.



She has her fish.
She has her bird.



Bob has his book.
He has his pencil.
He has his book.



He has his cup.
He has his dish.
The man has a cup in his hand.

The girl has a cup.
The girl has a dish.
The girl has a pan.

This is the girl's neck.
This is the girl's pan.

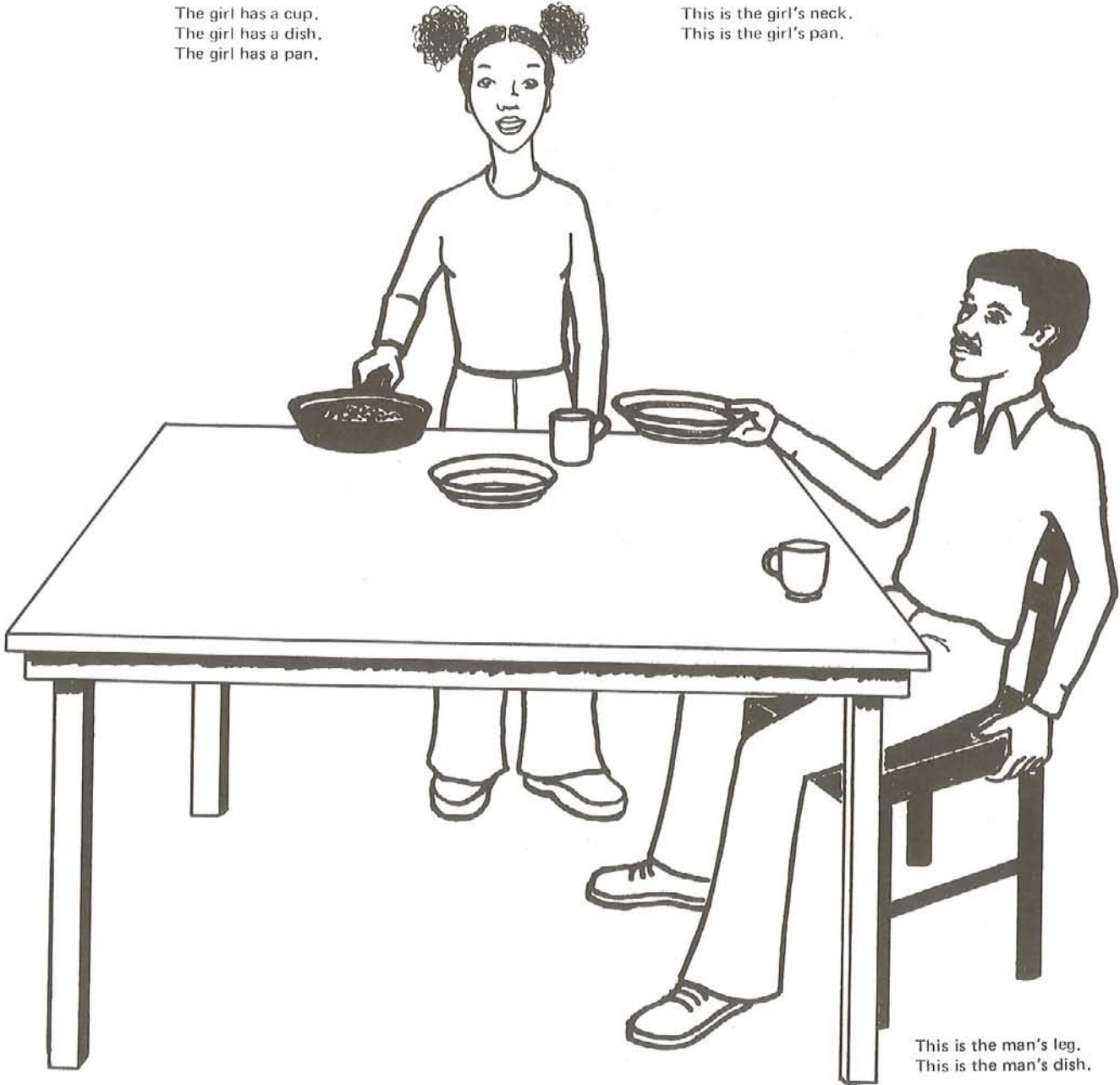

This is the man's leg.
This is the man's dish.

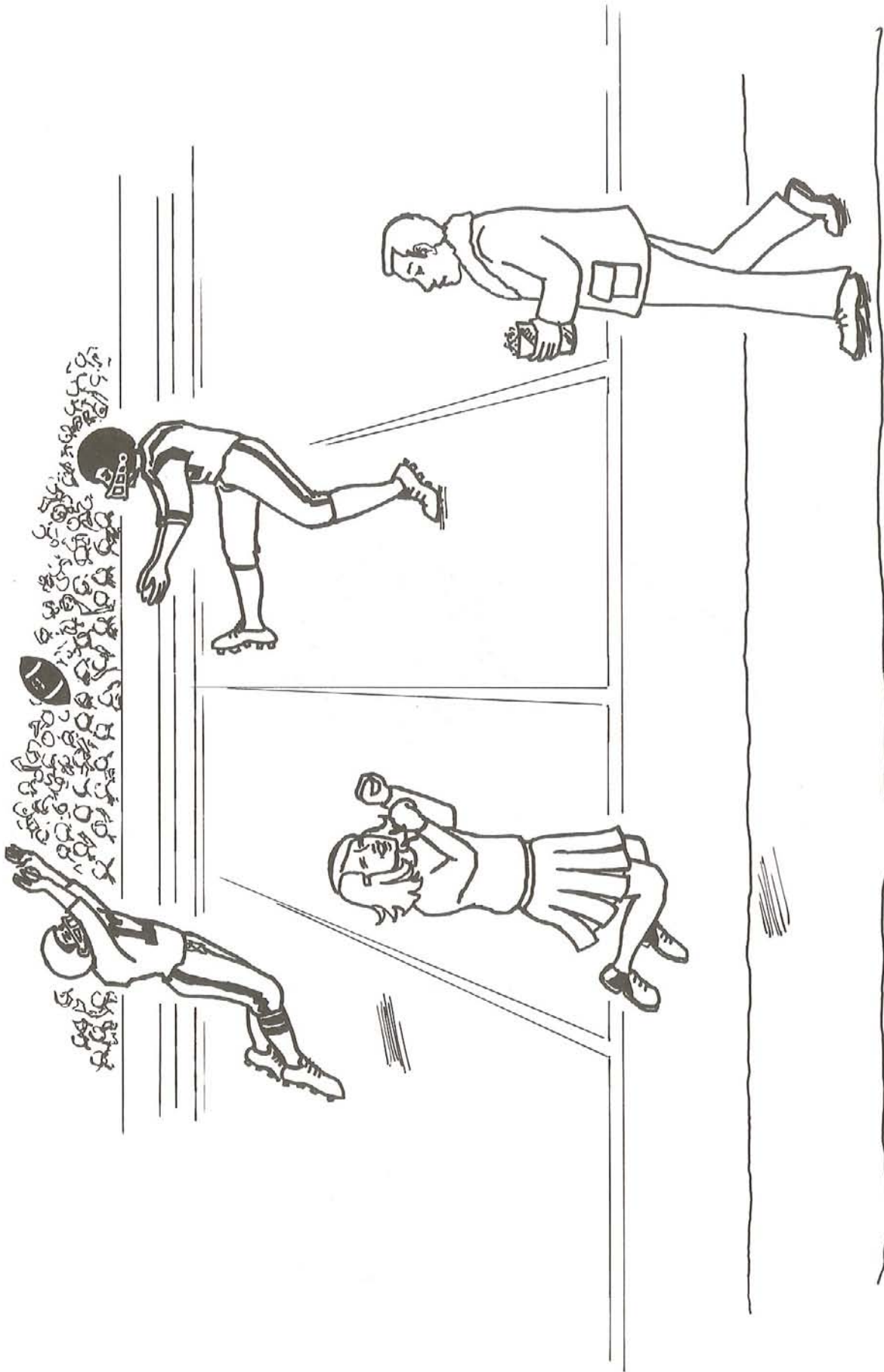

The man is jumping.

The girl is kicking.

The man is walking.

The man is kicking.

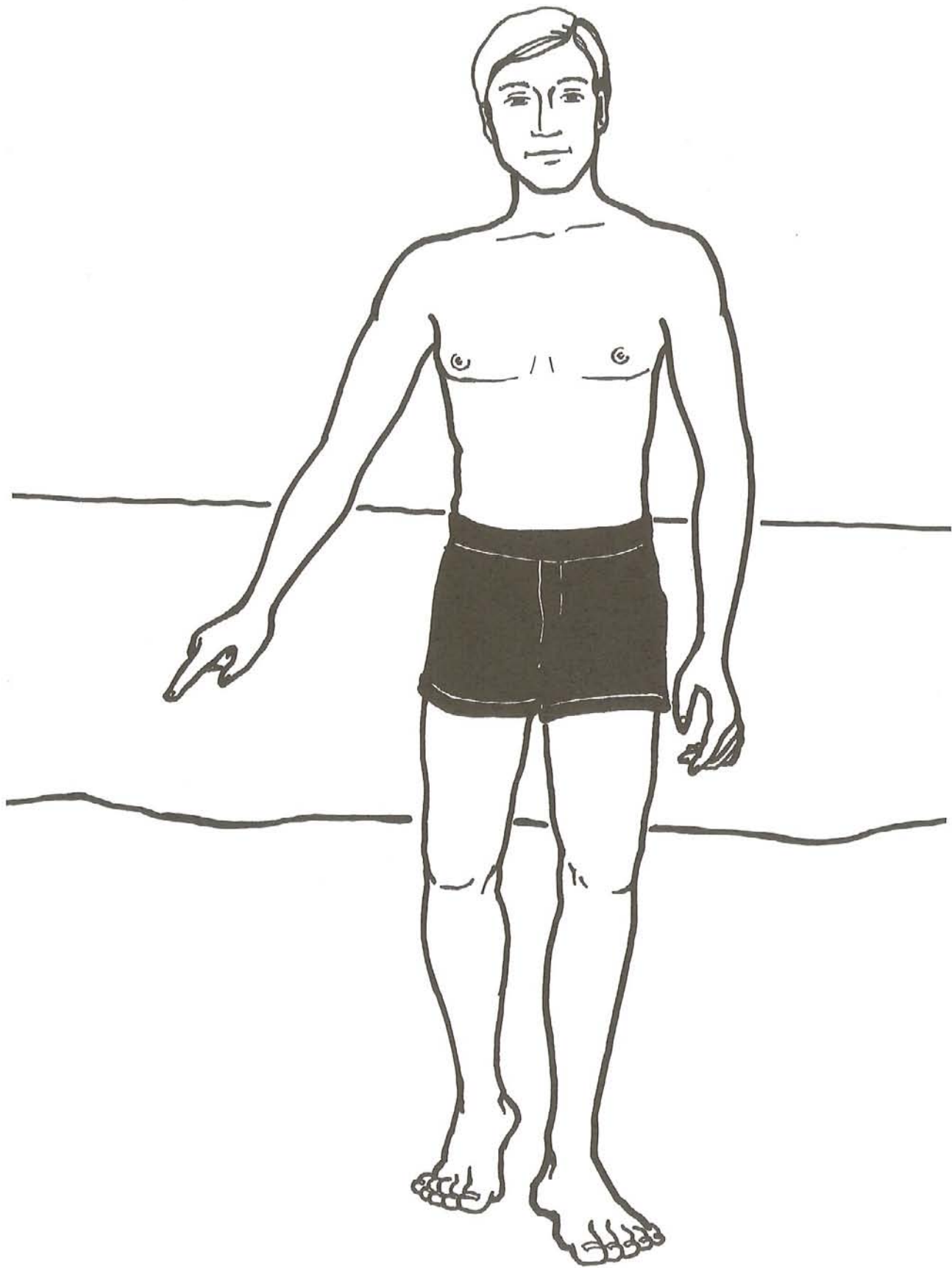

Parts of the Body



river

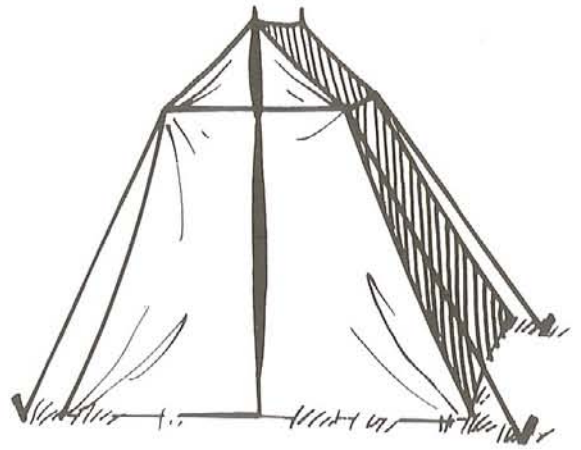

tent

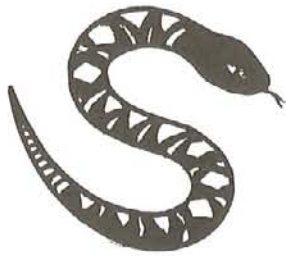

snake



valley

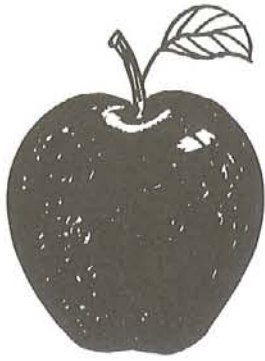

apple

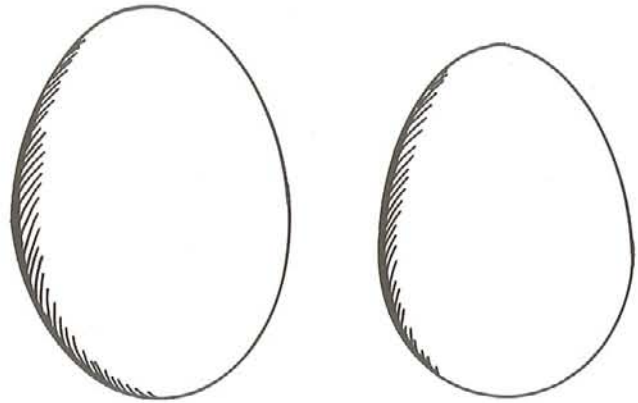

egg



orange



olive

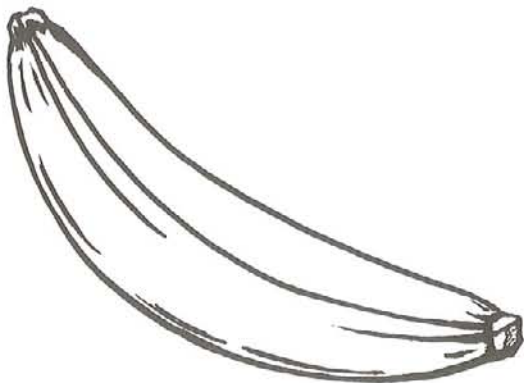

banana

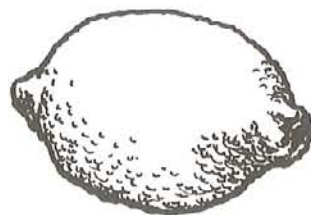

lemon

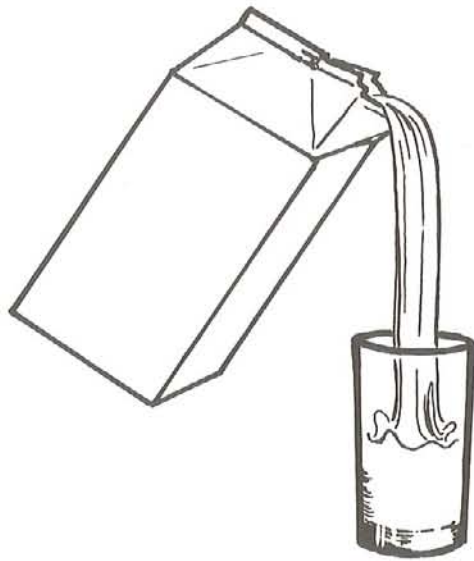

milk

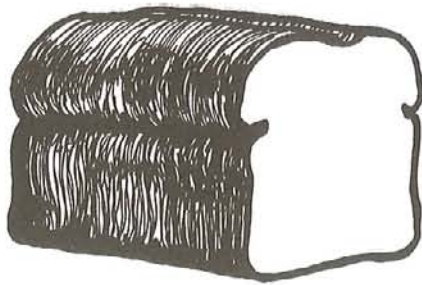

bread

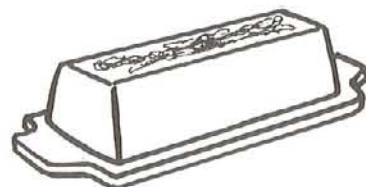
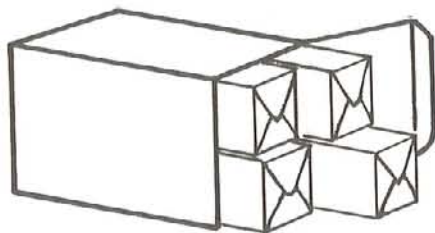

butter



sugar



coffee

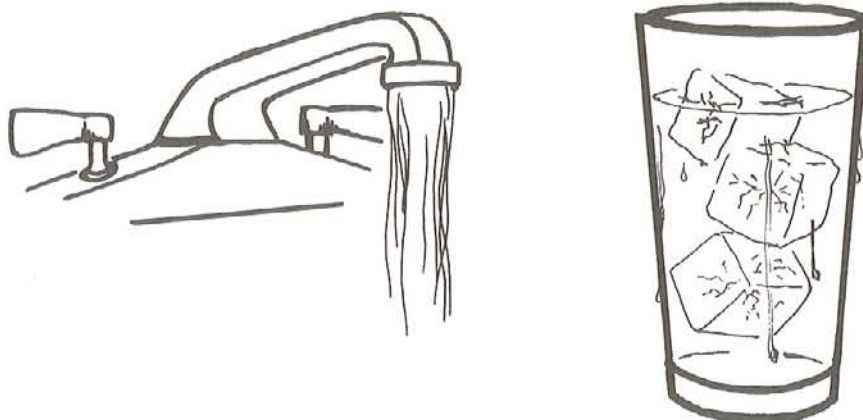

water

1

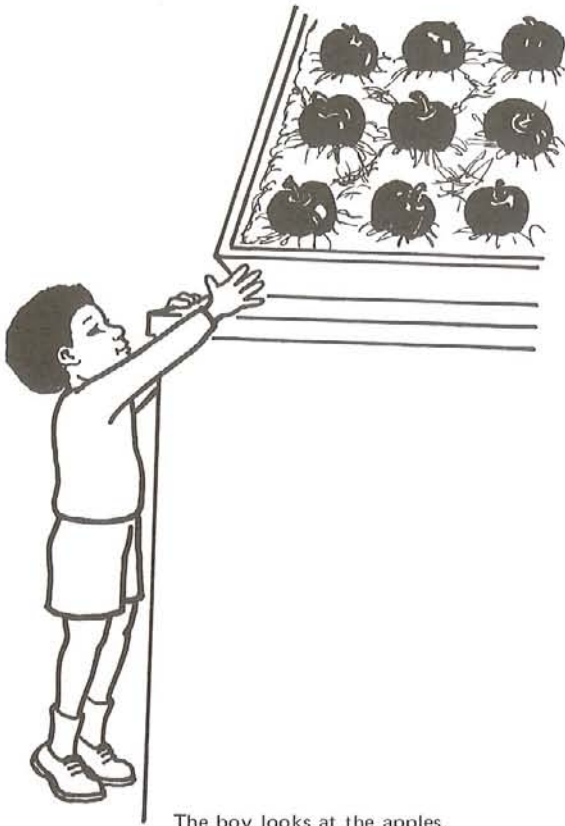

The boy looks at the apples.

2

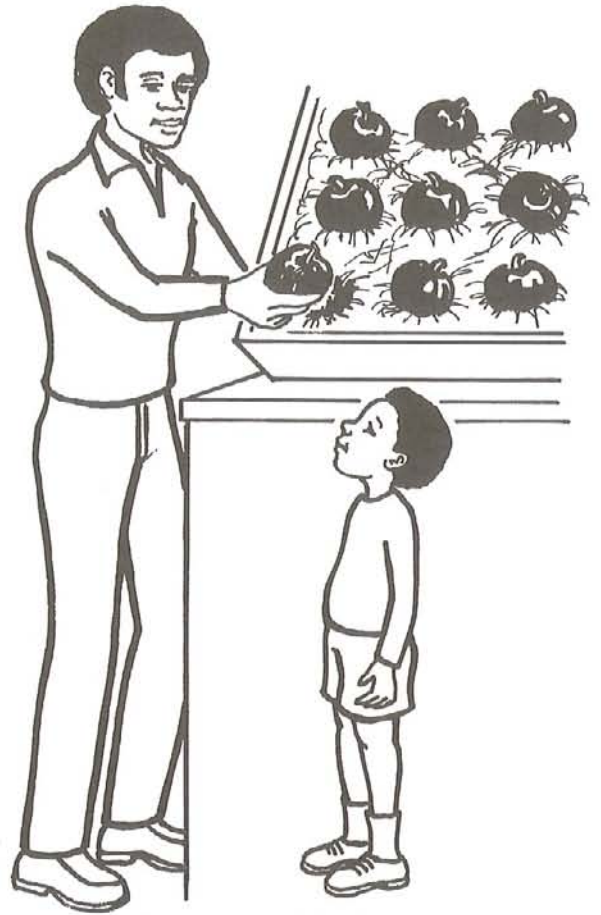

Bob gets an apple for the boy.

3

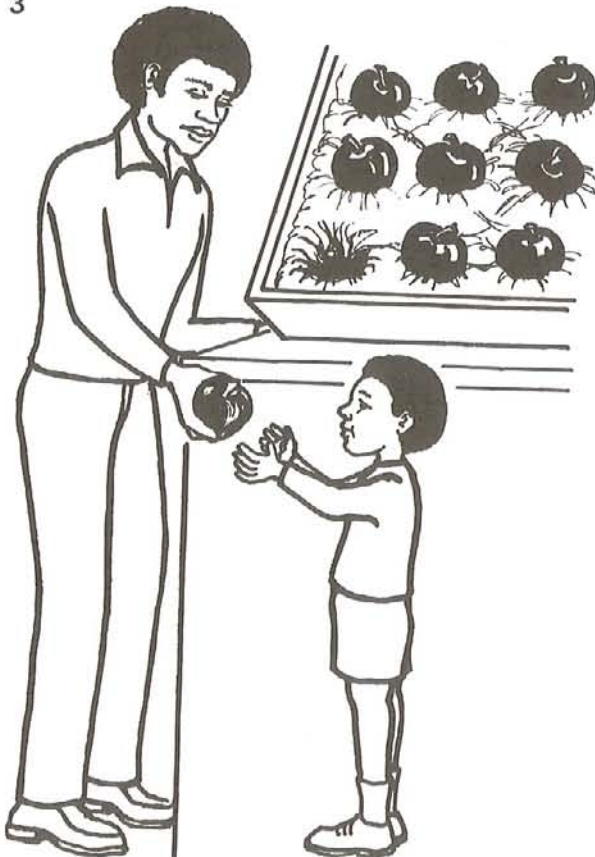

Bob gives an apple to the boy.

4

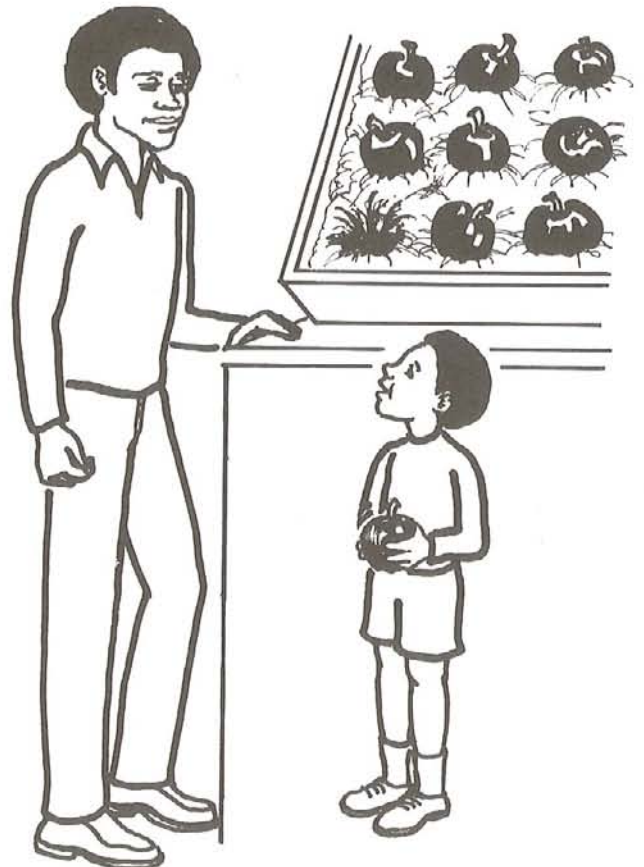

The boy says thank you.
The boy thanks Bob for the apple.



eating



drinking



I put the apple in the dish.

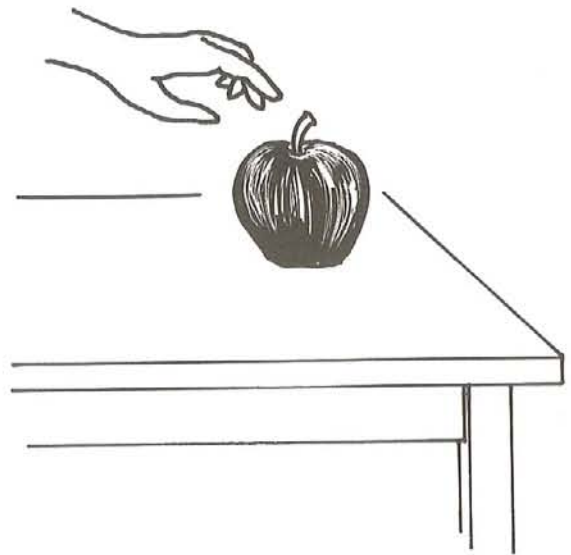

I put the apple on the table.

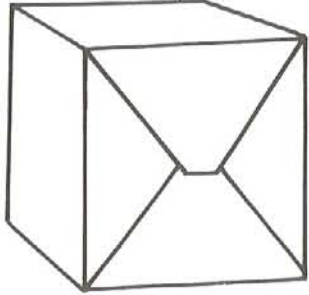

box

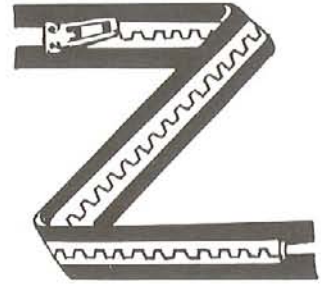

zipper



shop



children



The man sells the box for a quarter.



The girl buys the box for a quarter.

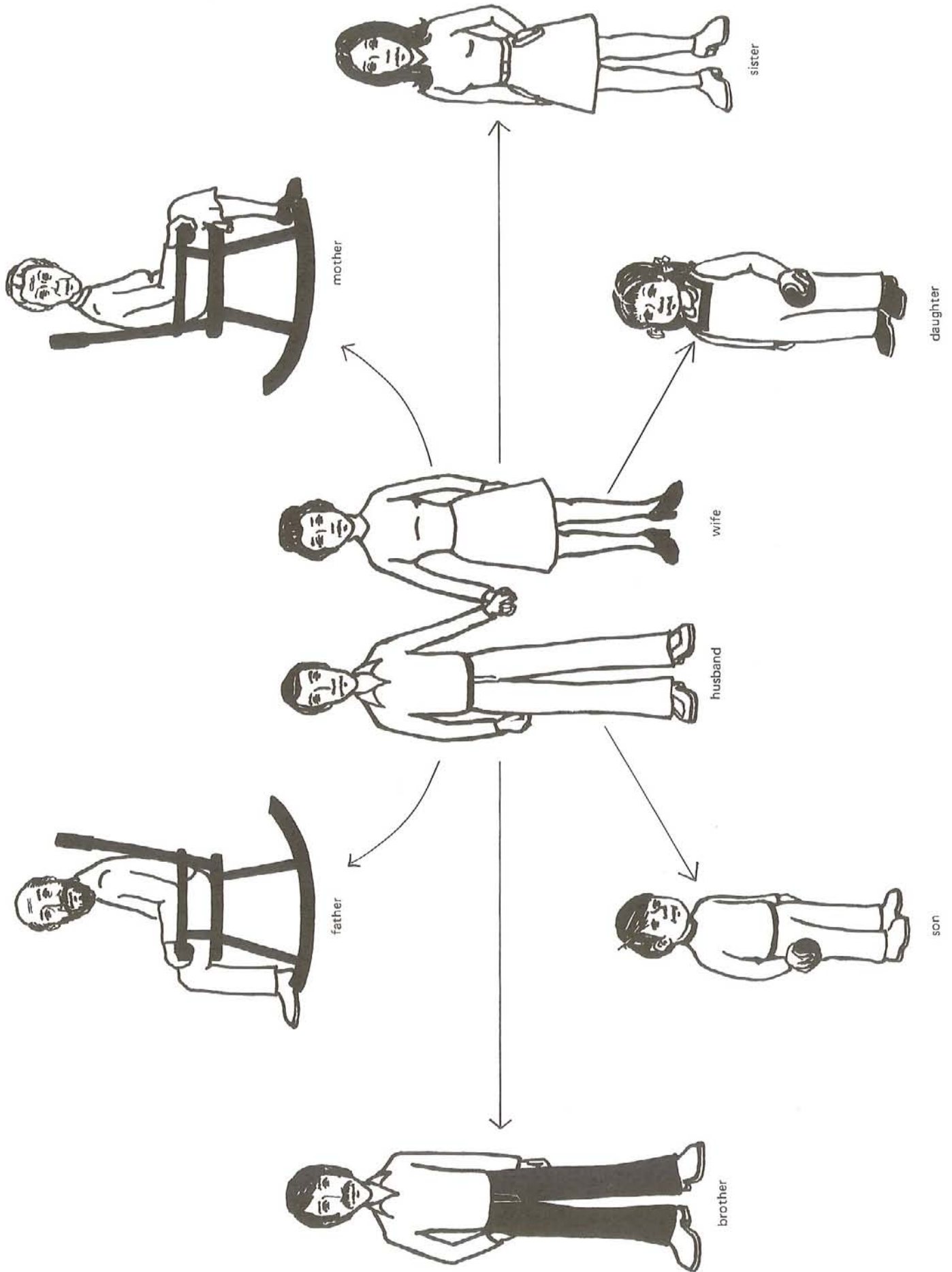

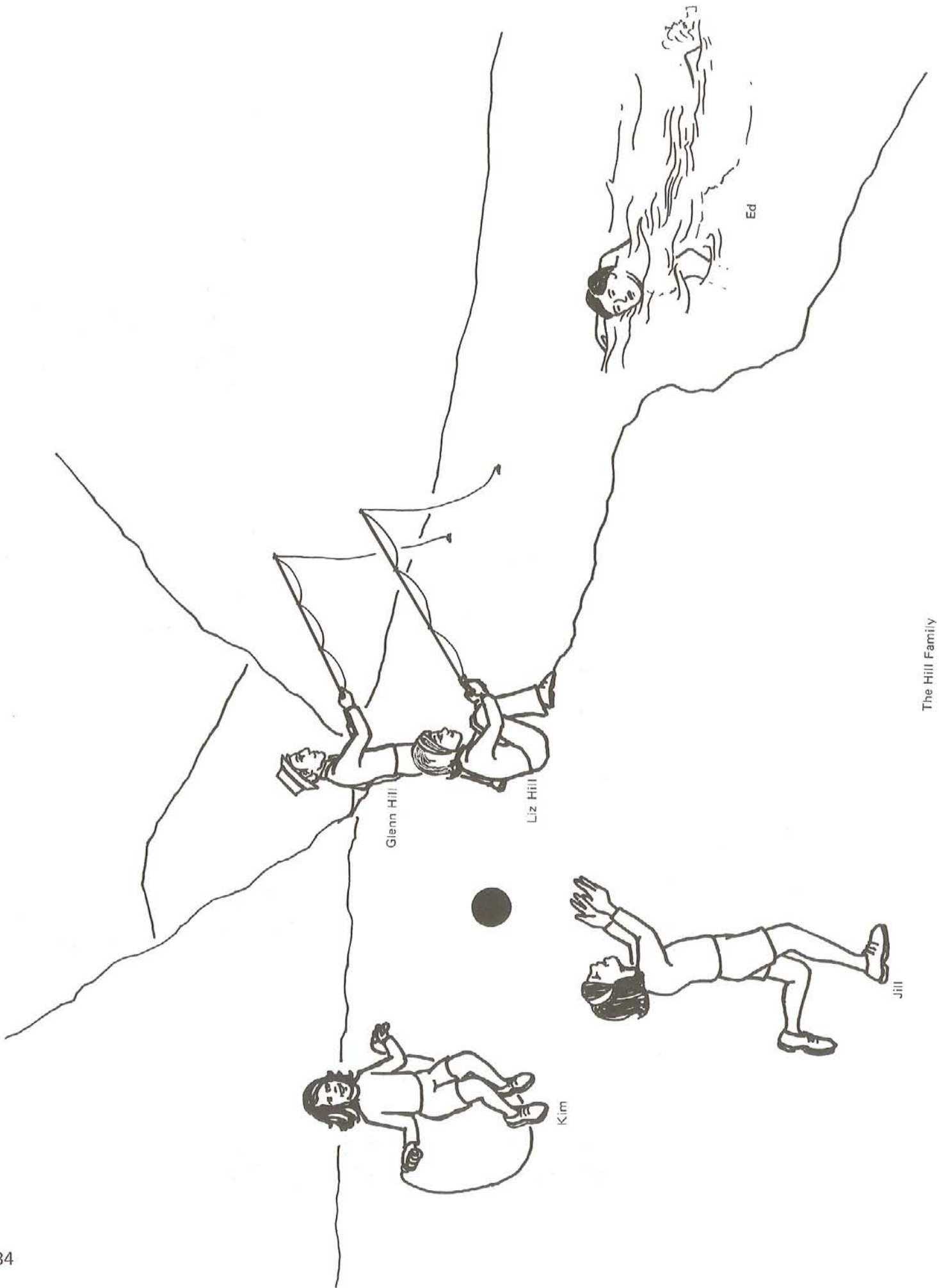

Glenn Hill

Liz Hill

Kim

Jill

Ed

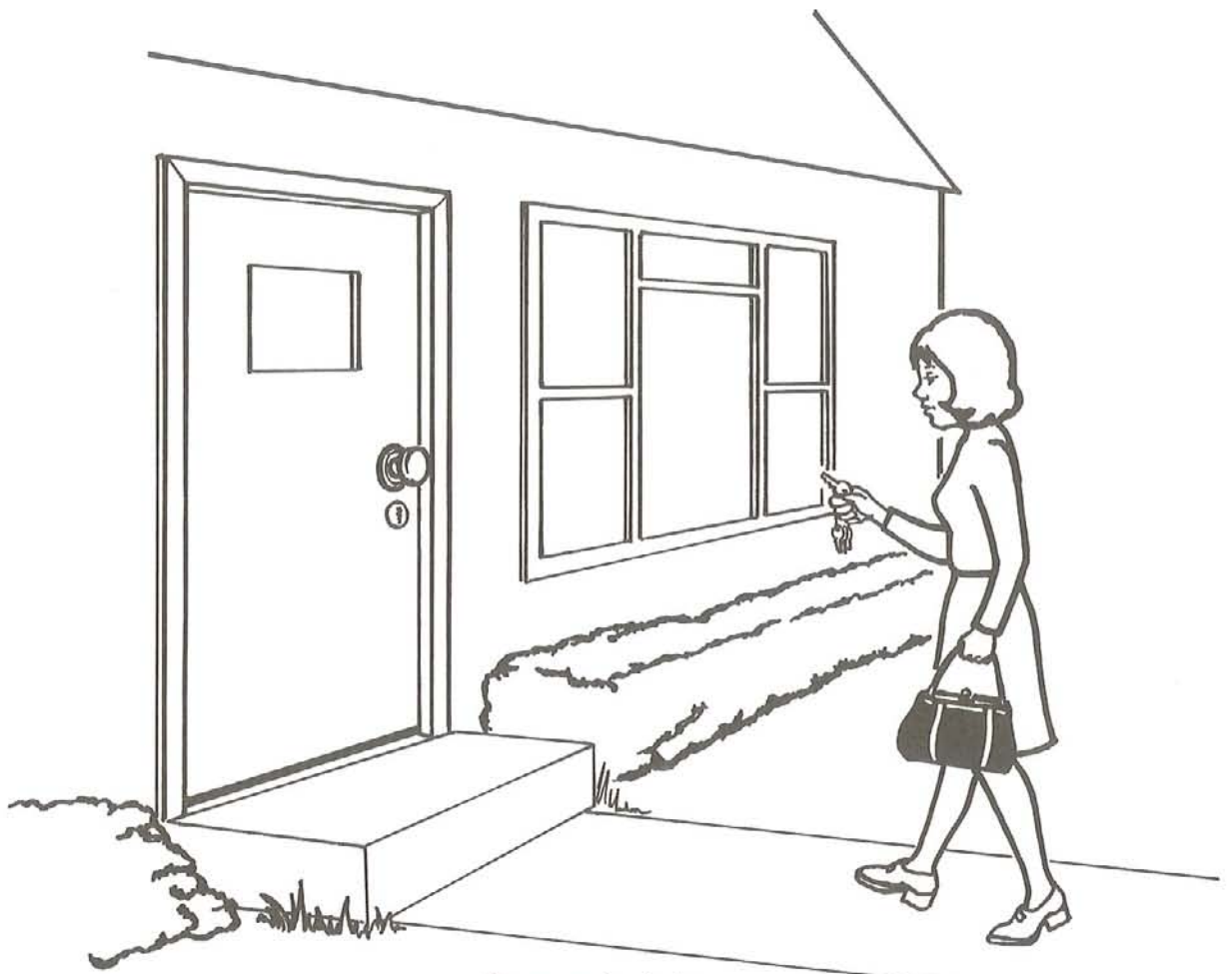

The woman is going home.



The woman is going downtown.

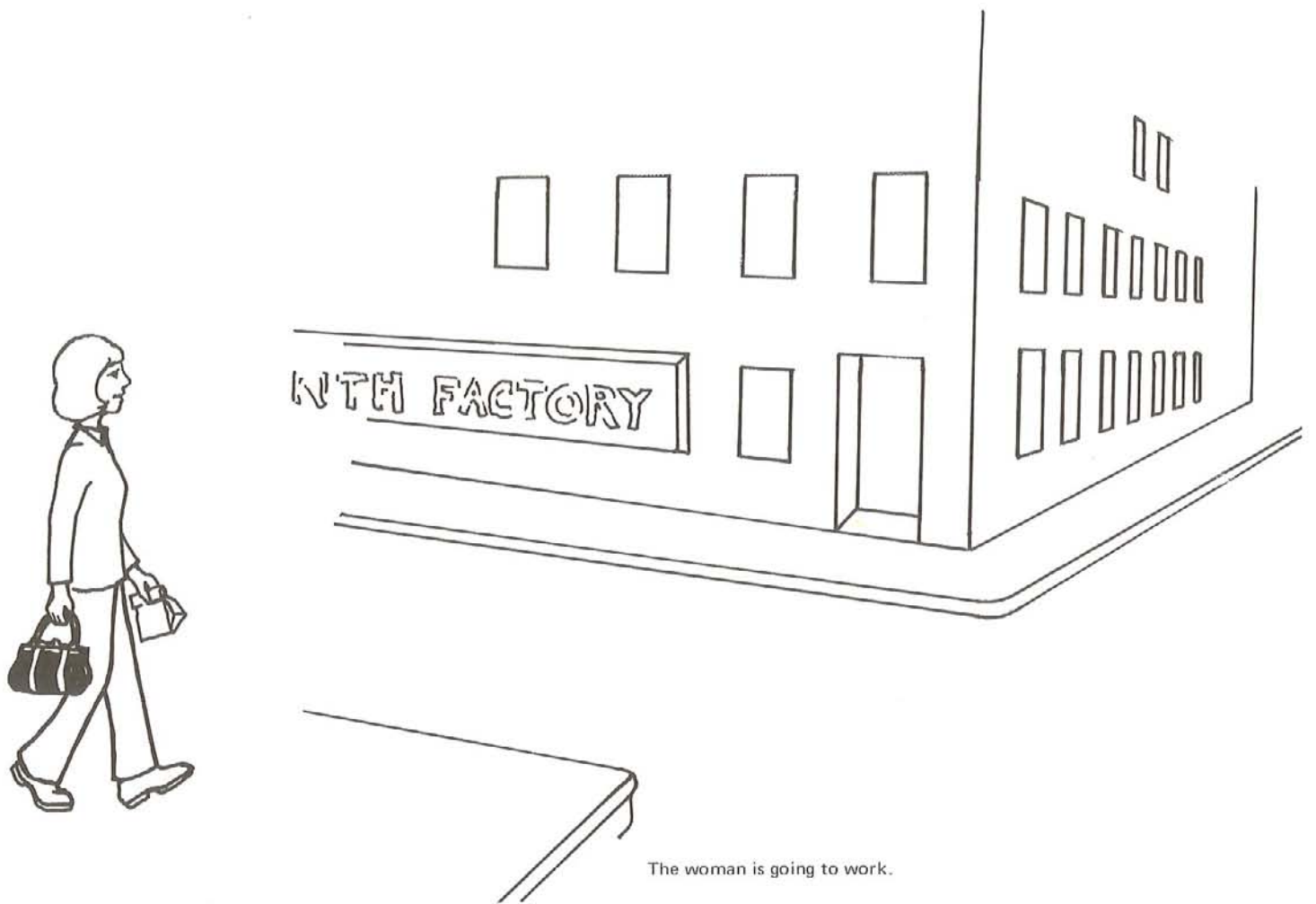

The woman is going to work.

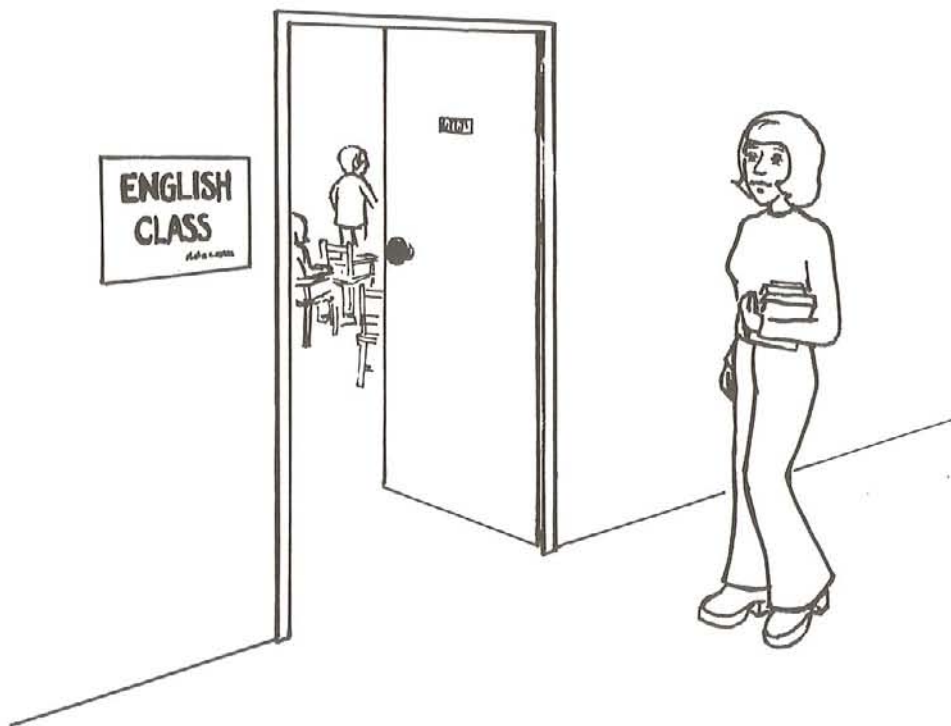

The woman is going to class.

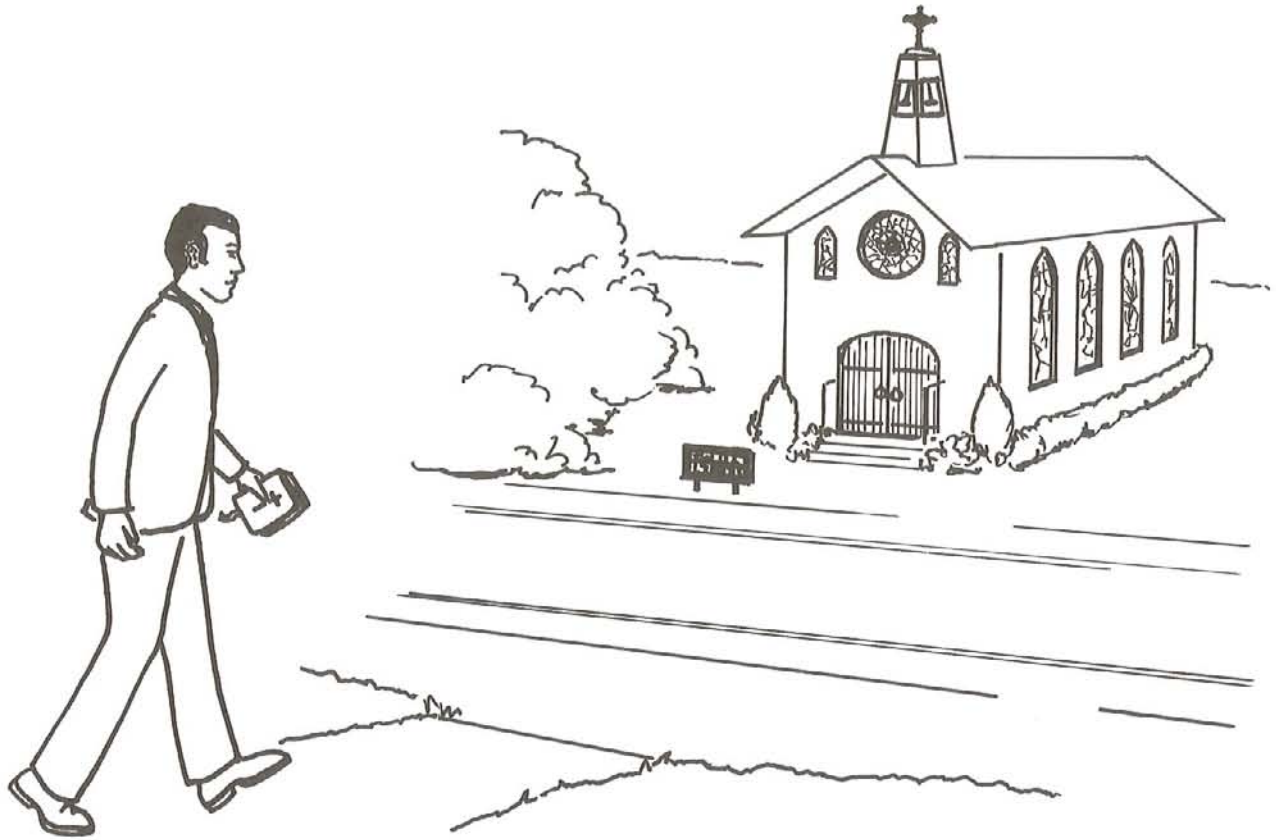

The man is going to church.

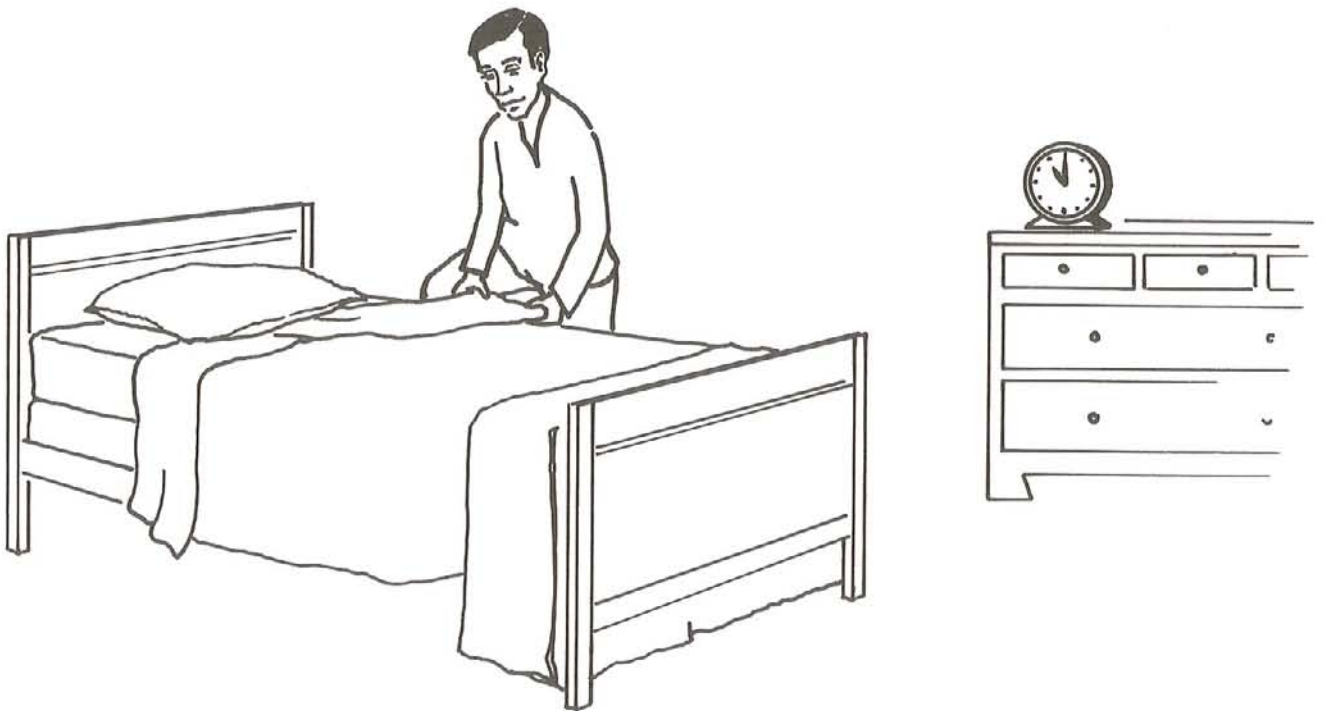

The man is going to bed.





dog



pup

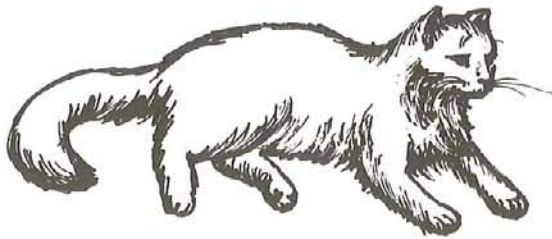

cat

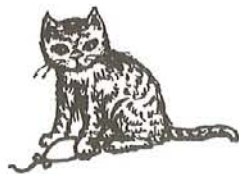

kitten



fish



bird

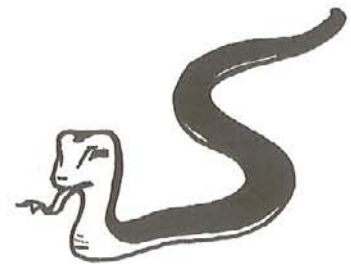

snake

1

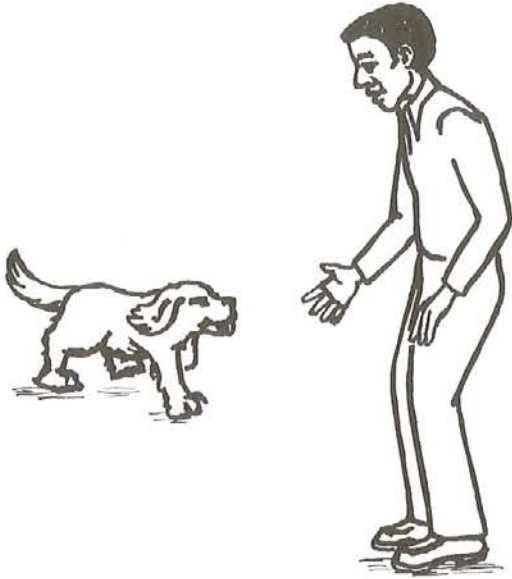

The pup runs to Mr. Oliver.

2



Mr. Oliver pats the pup.

3



Mr. Oliver picks up the pup.

4

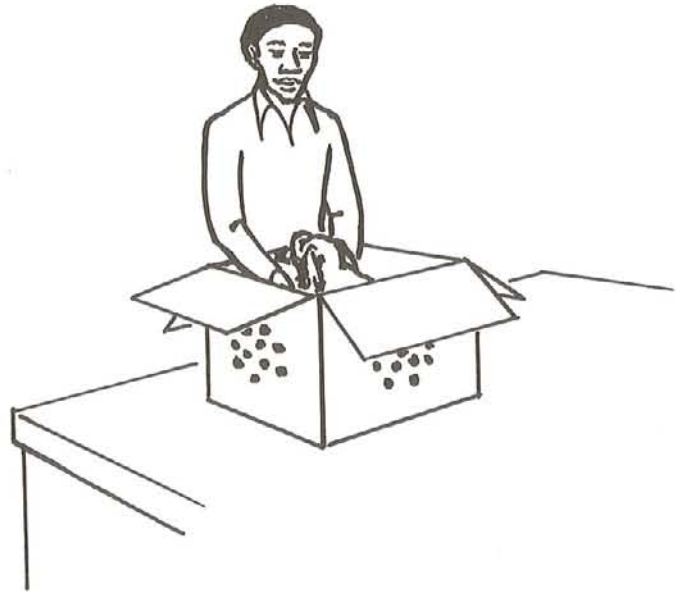

Mr. Oliver puts the pup in a box.

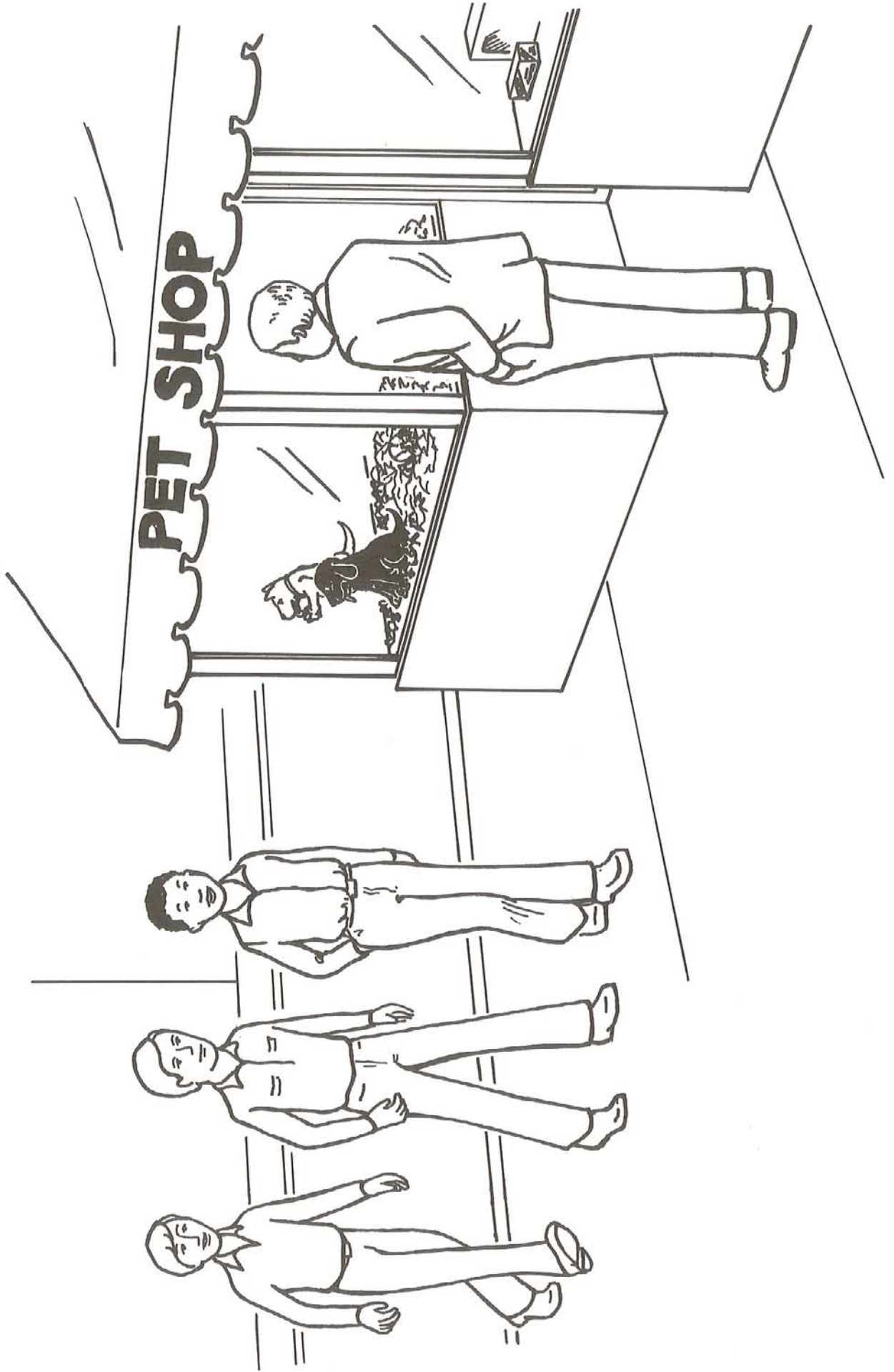

Uncle Ted

Will

Van

Sam

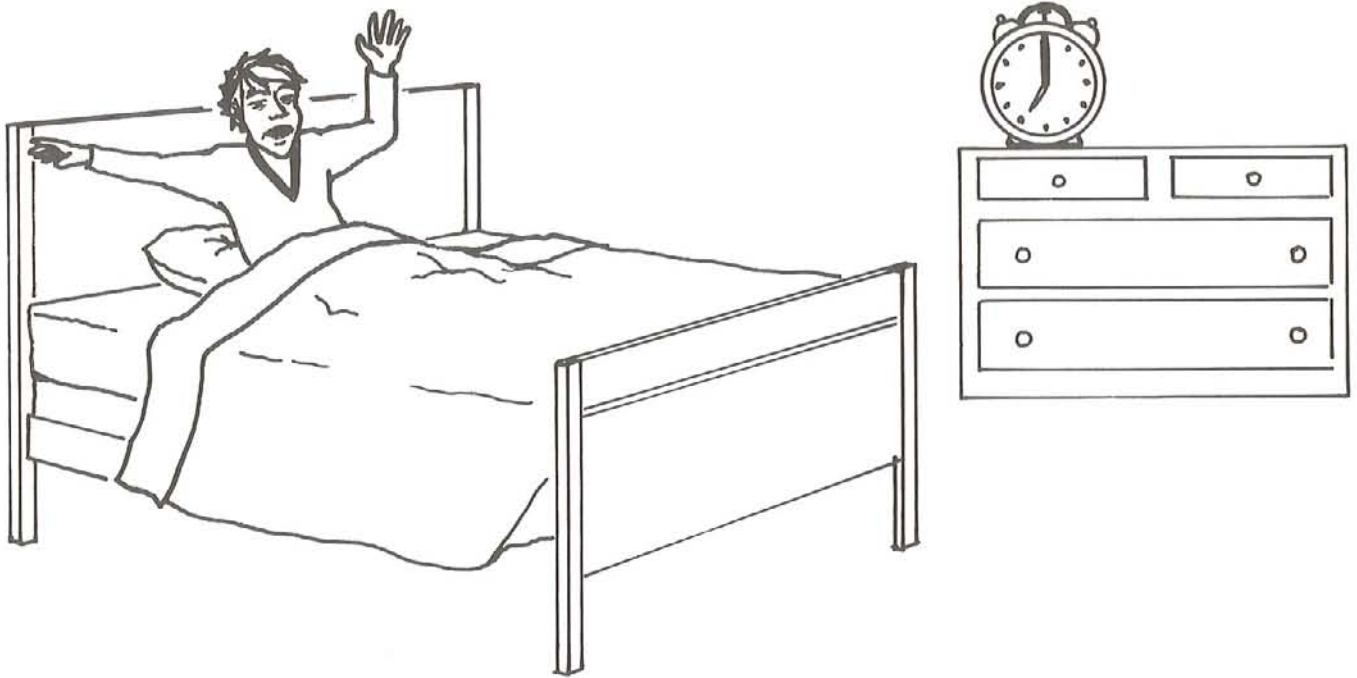

I get up in the morning.

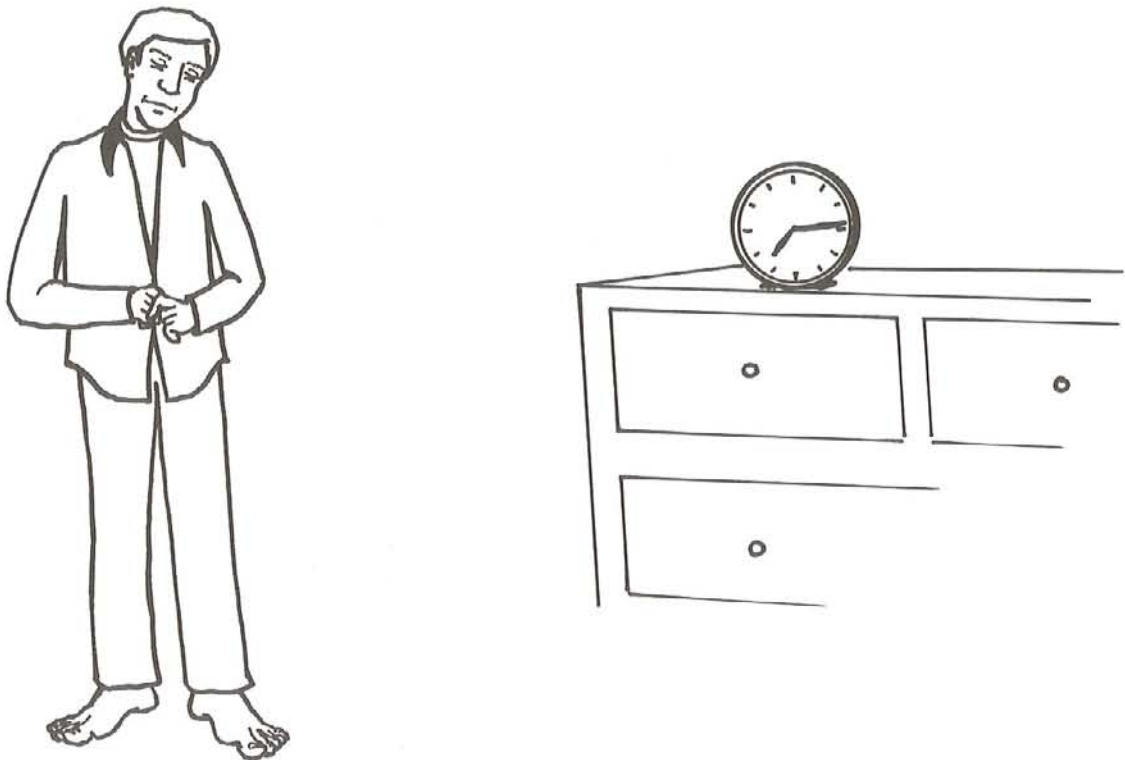

I get dressed in the morning.

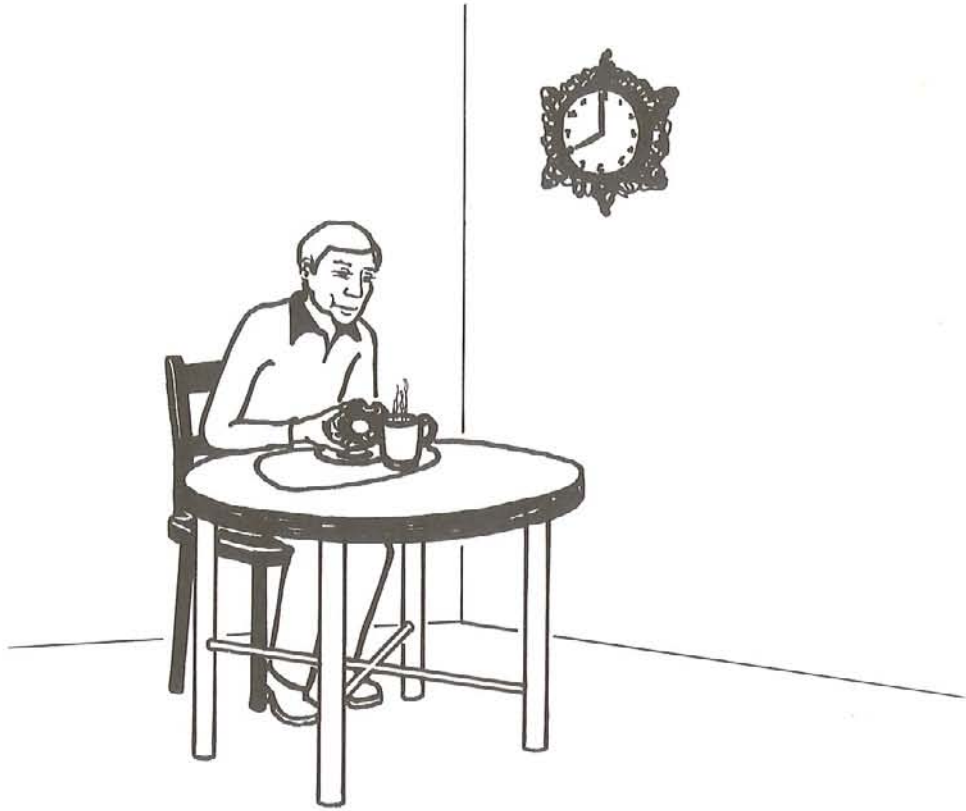

I have breakfast in the morning.



I go to work in the morning.

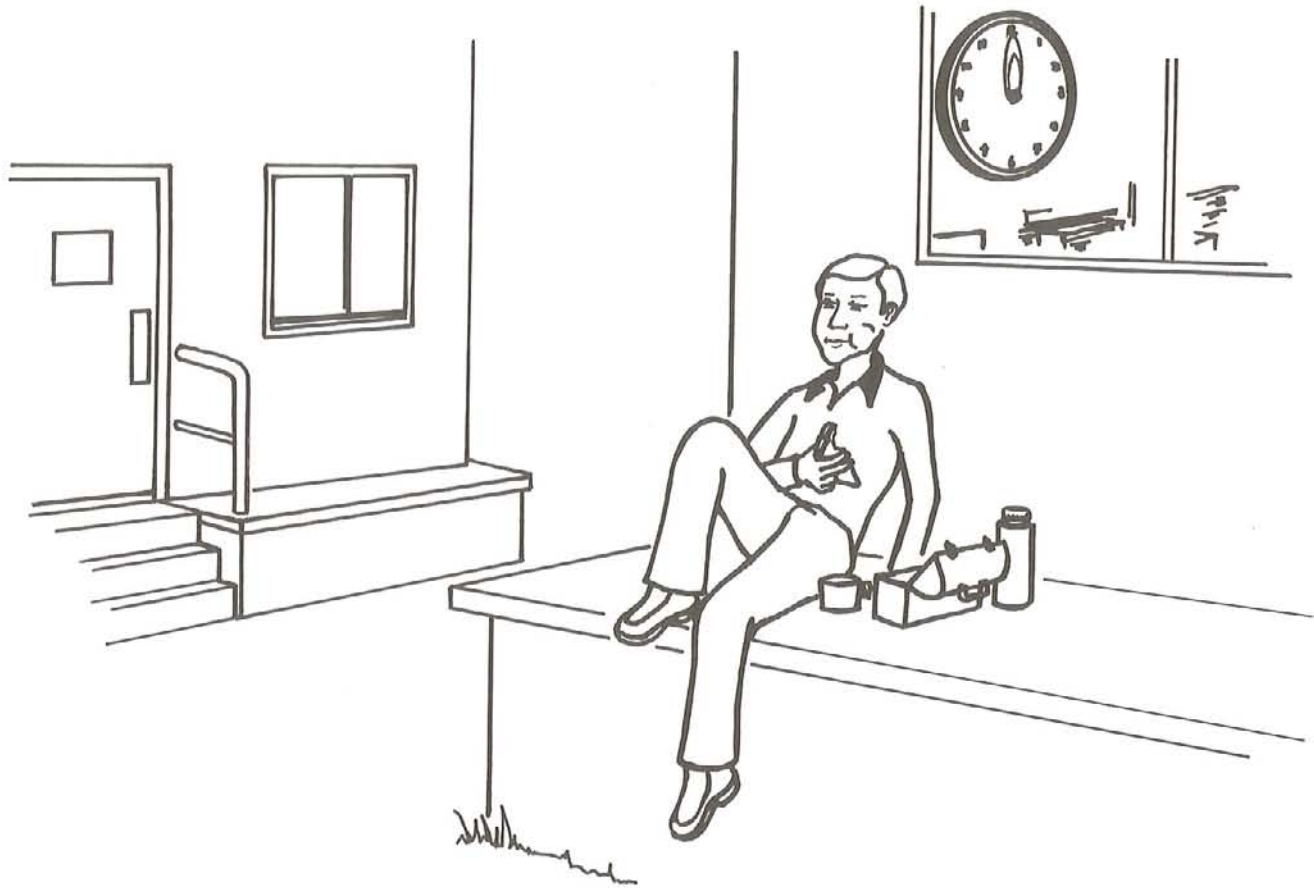

I have lunch at noon.



I go shopping in the afternoon.



I have dinner at 6 o'clock.

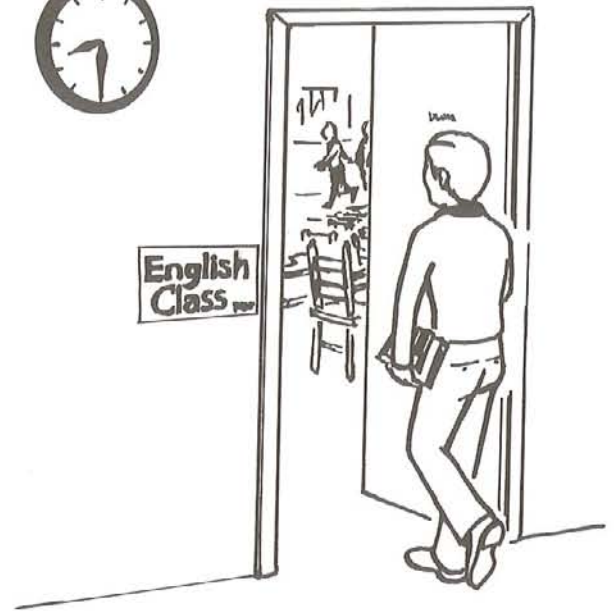

I go to class at night.



I go to bed at night.

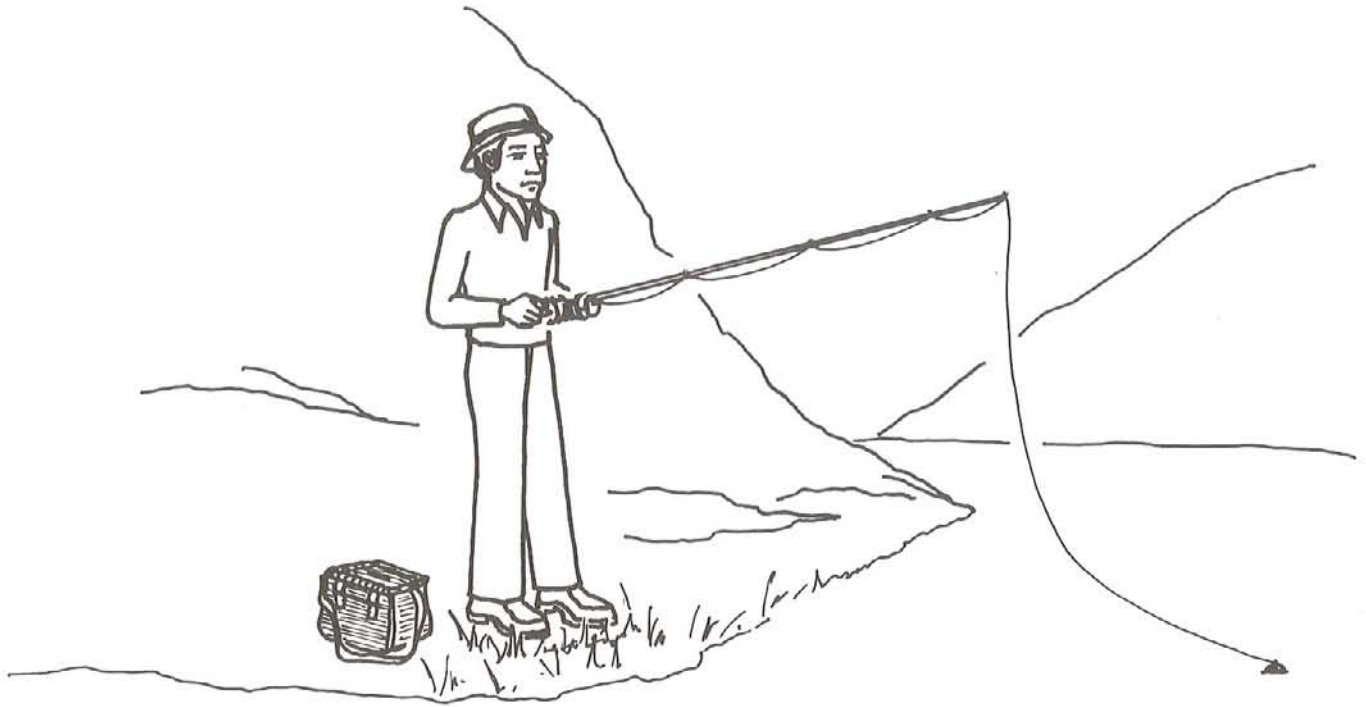

Mr. Hill is fishing in the river.



Glenn is sailing.



Jill is swimming.



Glenn and Liz are camping.



Sam is hunting.



Will is hiking.

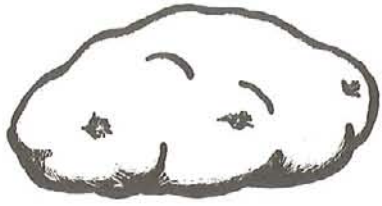

potato

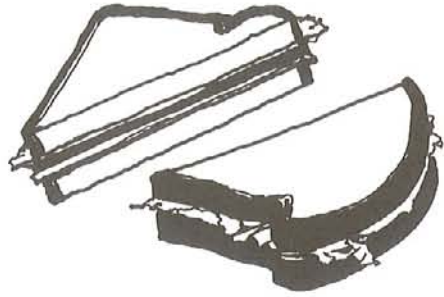

sandwich

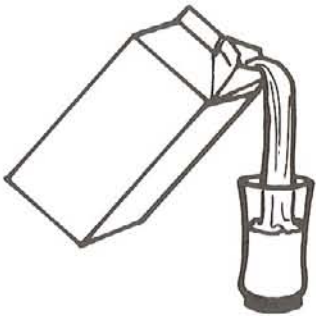

glass of milk

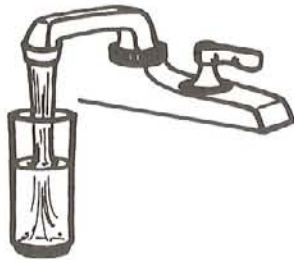

glass of water

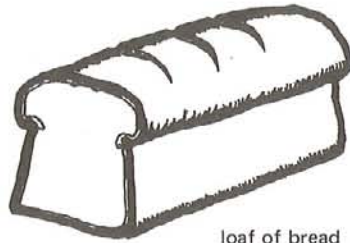

loaf of bread



piece of bread



cup of soup



cup of coffee

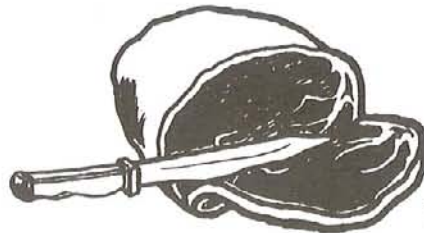

piece of meat

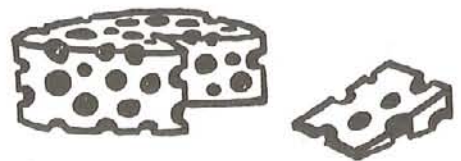

piece of cheese